

## Anbauanleitung Seilwindenanbausatz VW Amarok *Installation Instruction winch mounting kit VW Amarok*

Best.-Nr.: 16 - 5380

AL: 2008 – 06



**Hier sehen sie den fertig montierten Seilwindenanbausatz.  
Bevor sie mit der Montage beginnen, lesen sie bitte diese Anleitung  
und das Benutzerhandbuch der Seilwinde gut durch.**

### **Achtung:**

Bei Fahrten im öffentlichen Straßenverkehr muß das Rollenseilfenster mit einer Kunststoffabdeckung abgedeckt werden.

# Stückliste Seilwindenanbausatz VW Amarok

Partlist winch mounting kit VW Amarok

Best.nr.: 16 - 5380

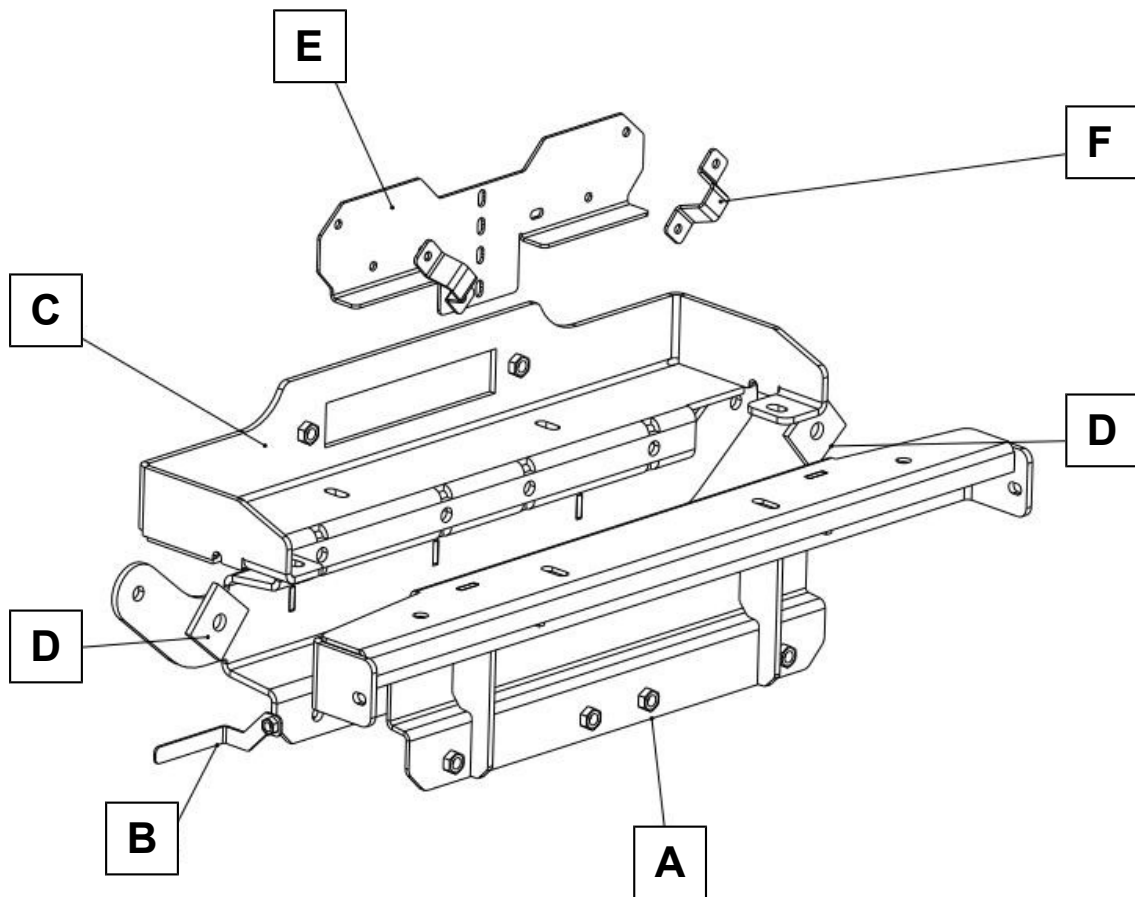

1 x Seilwindenträger hinten ( A )	2 x Schraube M 12 x 40
1 x Halter mit Mutter ( B )	4 x U-Scheibe M 12 x 40 x 3
1 x Seilwindenträger vorne ( C )	2 x Federring M 12
2 x Distanzplatte ( D )	2 x Mutter M 12
1 x Schaltkastenhalter ( E )	10 x Schraube M 10 x 30
2 x Schelle ( F )	2 x Schraube M 10 x 25
1 x Anbauanleitung AL 2008	14 x U-Scheibe M 10 x 30 x 2
1 x Gutachten	12 x Federring M 10
	2 x Schraube M 8 x 30
	2 x U – Scheibe M 8
	4 x U-Scheibe M8 x 25 x 2
	2 x Federring M 8
	2 x Schraube M 6 x 20
	4 x Schraube M 6 x 30
	8 x U-Scheibe M 6
	4 x U – Scheibe M6 x 15 x 1,5
	6 x Federring M 6
	6 x Mutter M 6

**Achtung:** Wenn sie eine **ZEON** Winde verbauen möchten, empfehlen wir dringend die Verwendung der Steckdosenverlängerung 1- 90394 !

**Attention:** If you want to fit a **ZEON** winch, we recommend to use the socket extension kit 1-90394 !

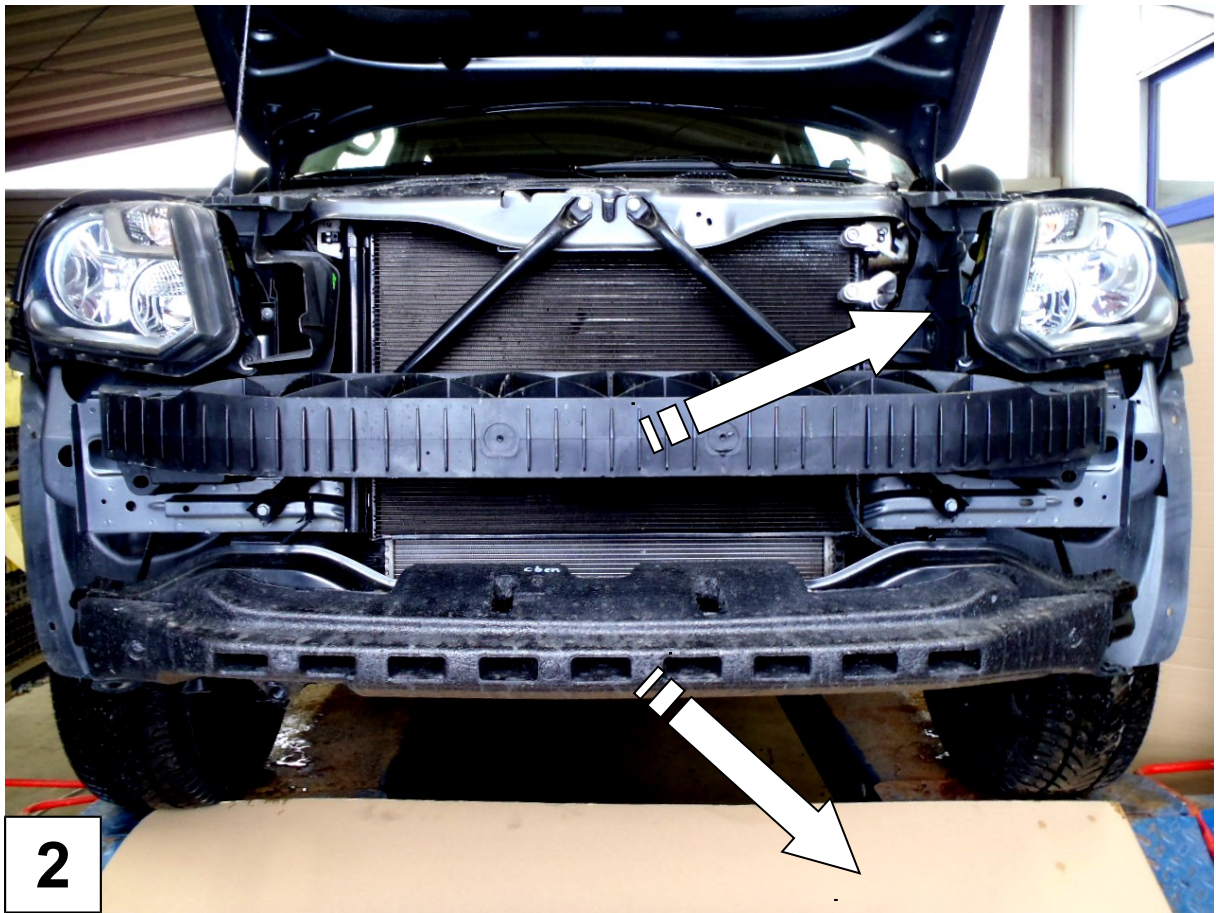

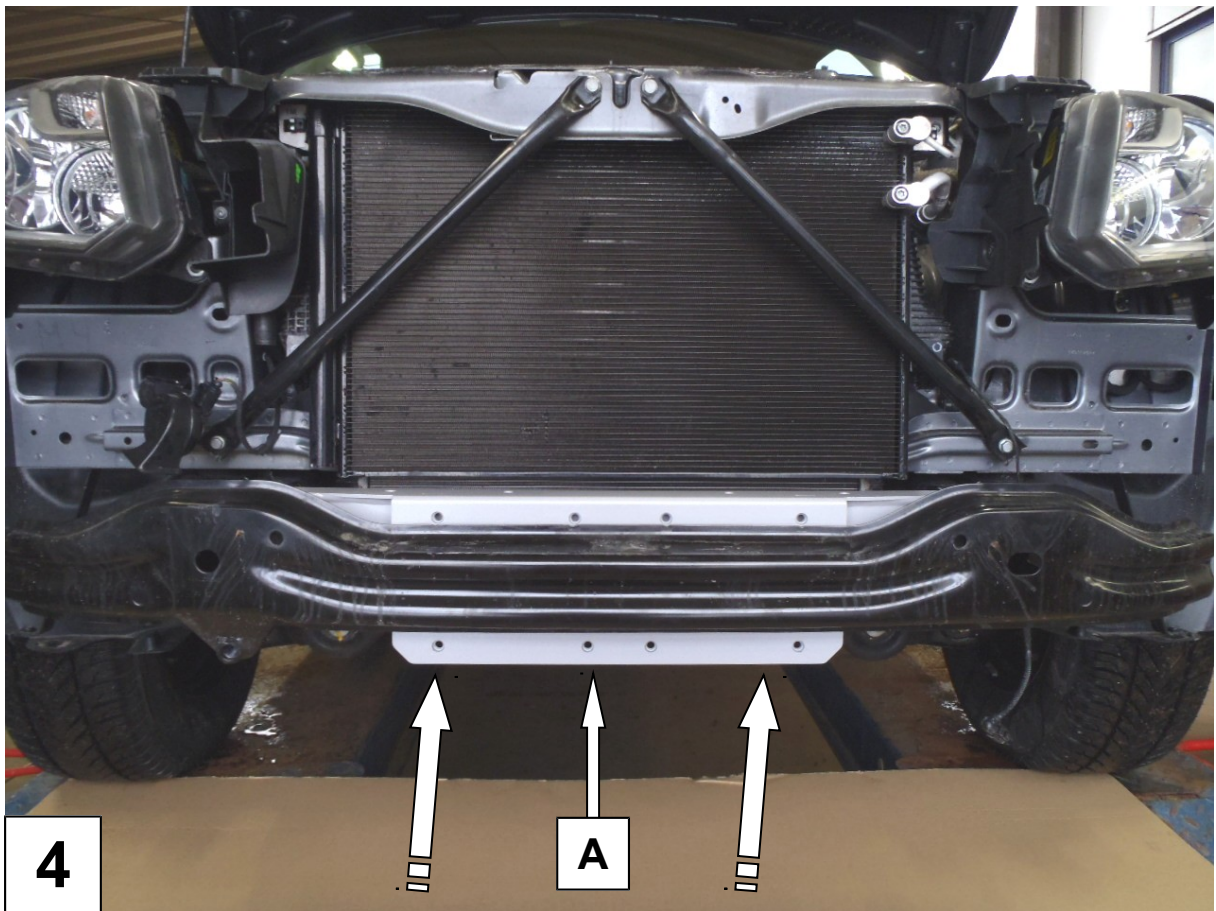

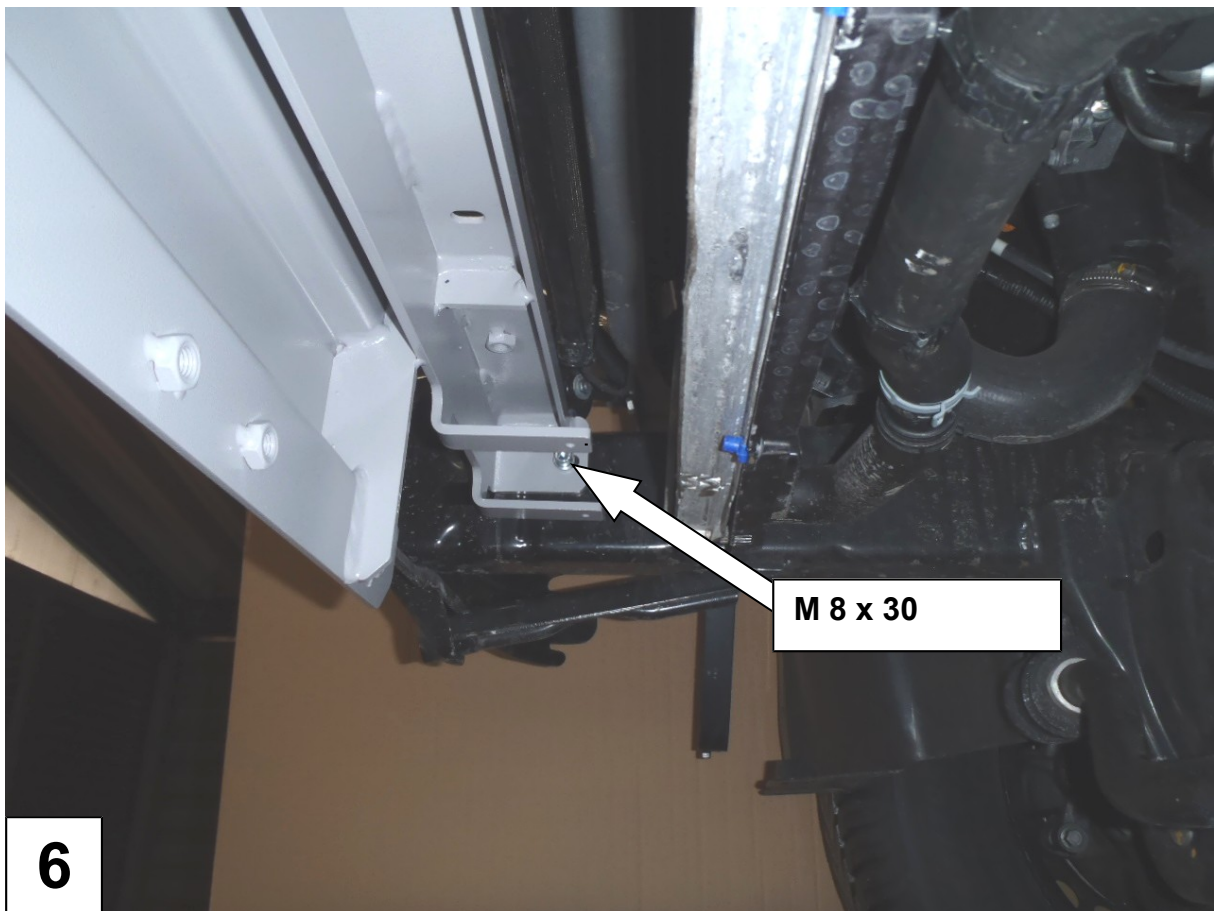
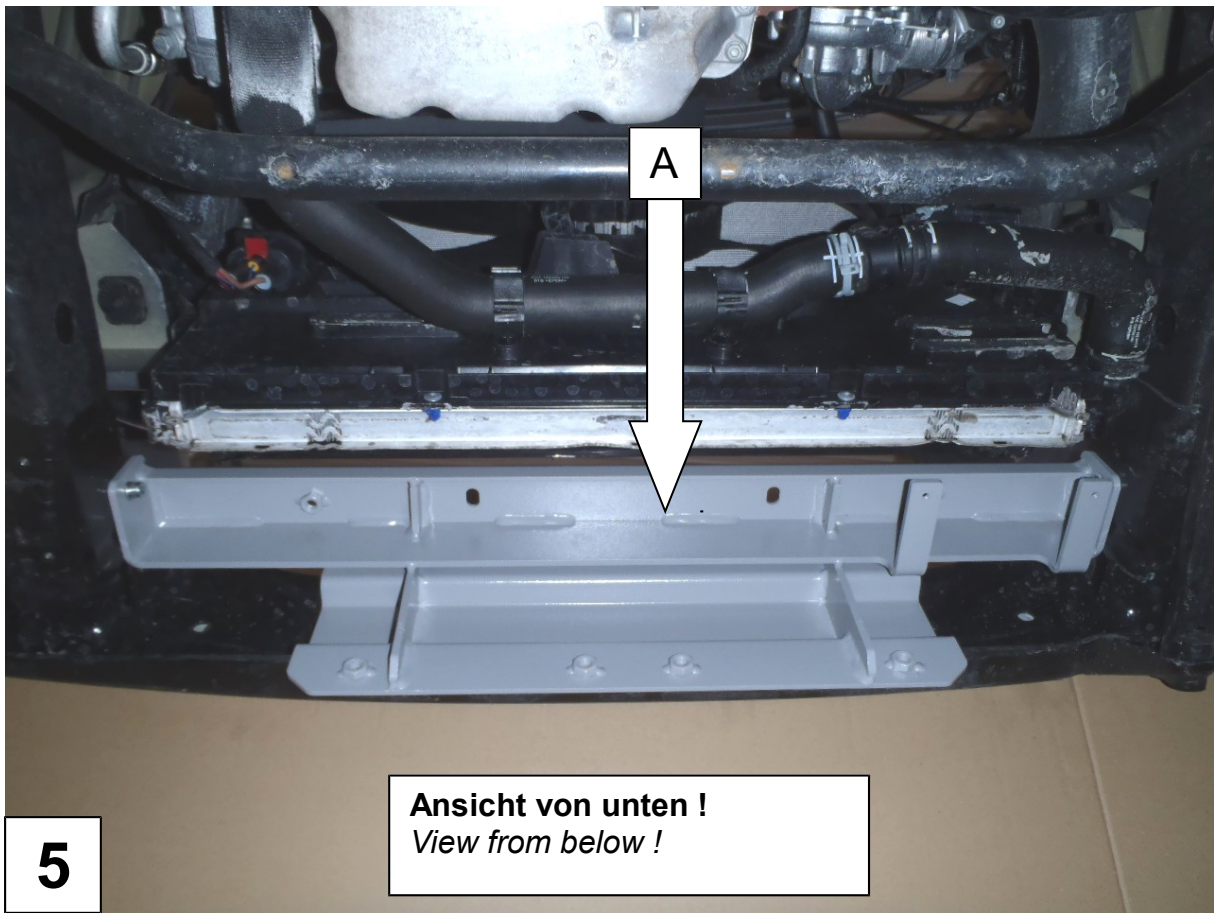

Toleranzen sollten mit den U-Scheiben 8 x 25 x 2 ausgeglichen werden!  
*Tolerances should get balanced with the shims 8 x 25 x 2!*

M 8 x 30

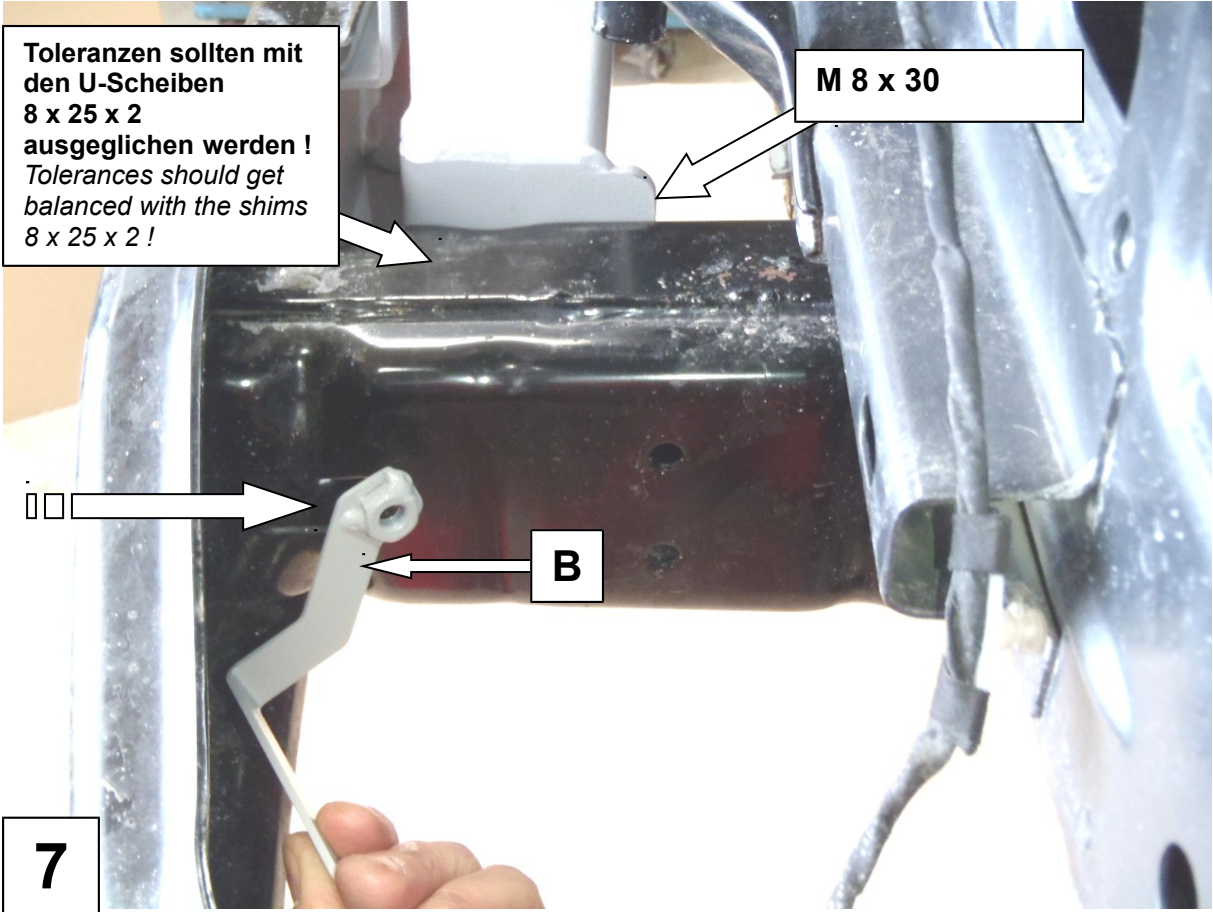

7

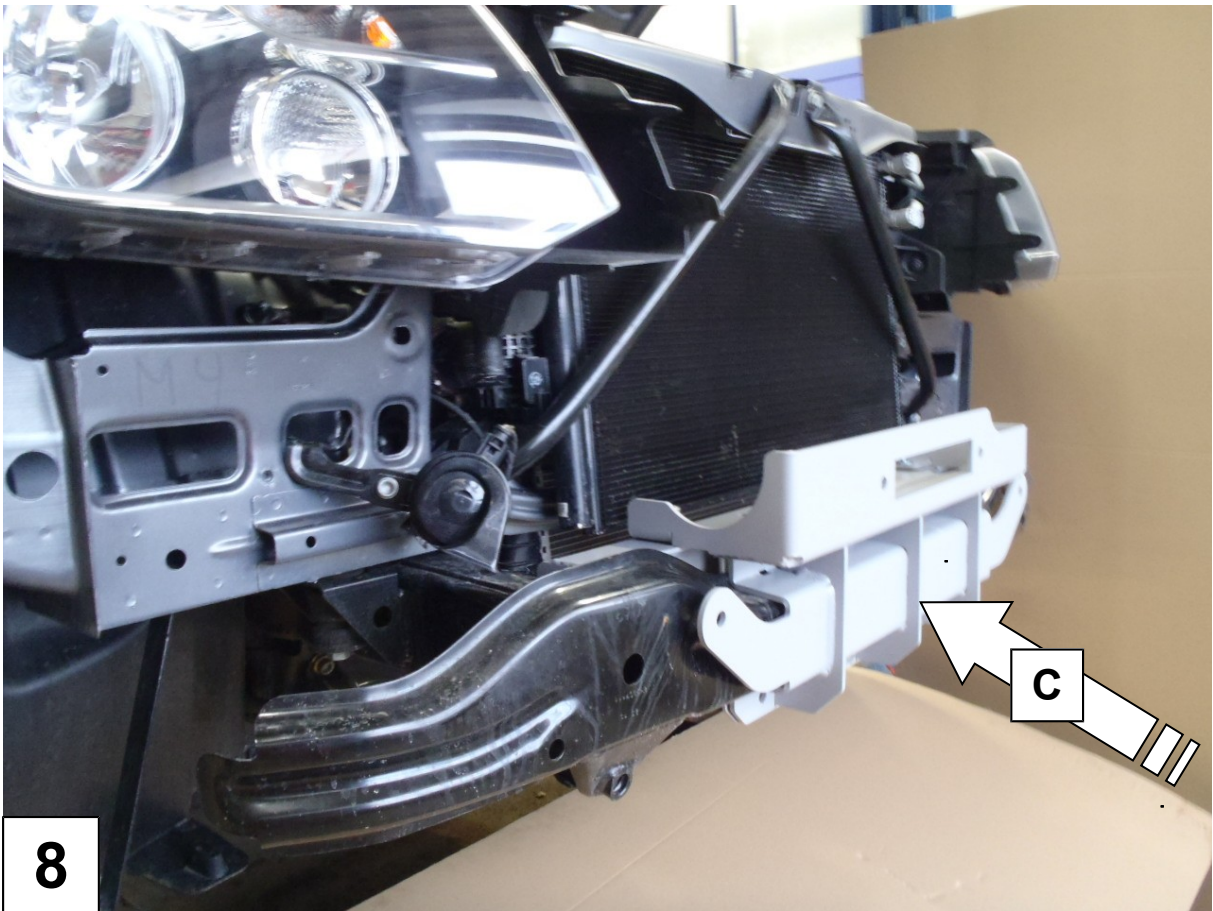

8

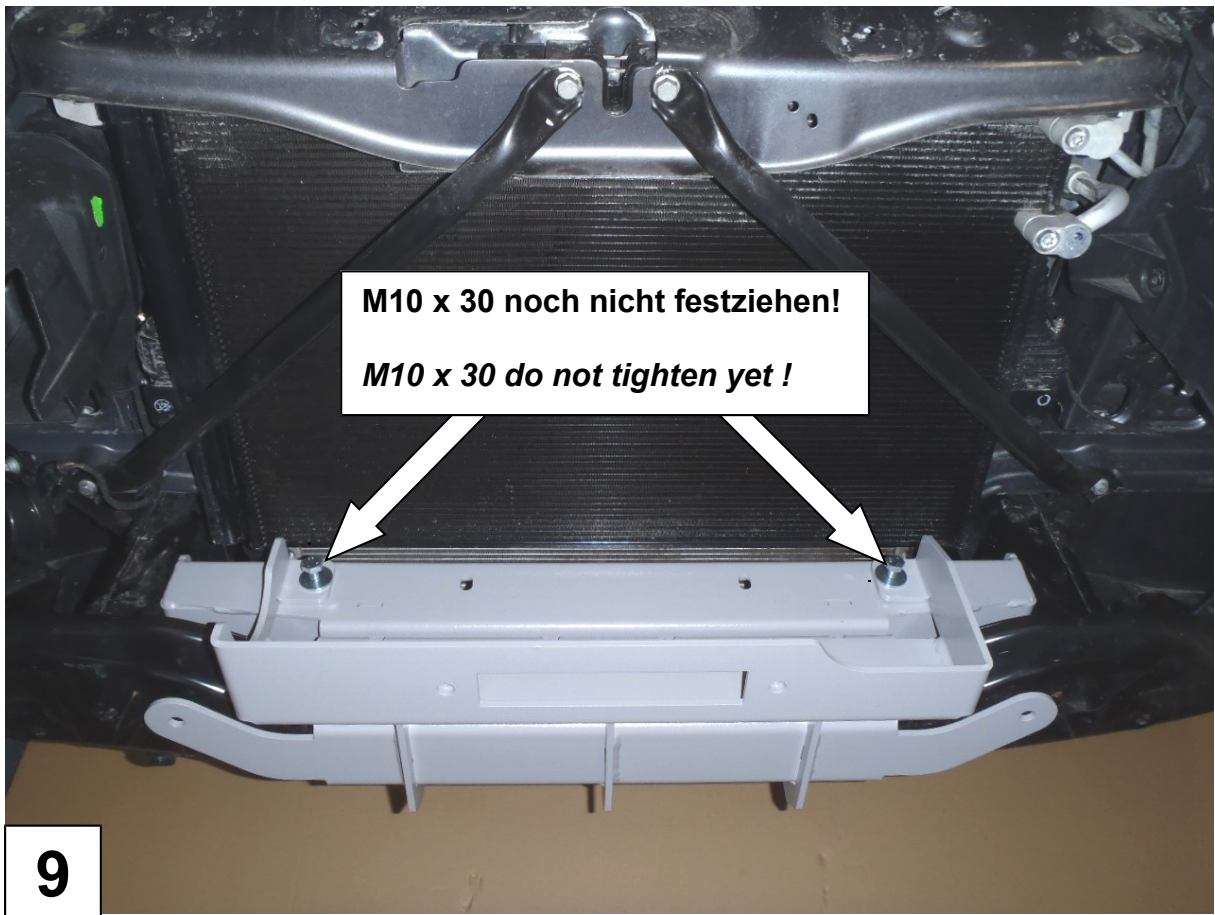

**9**

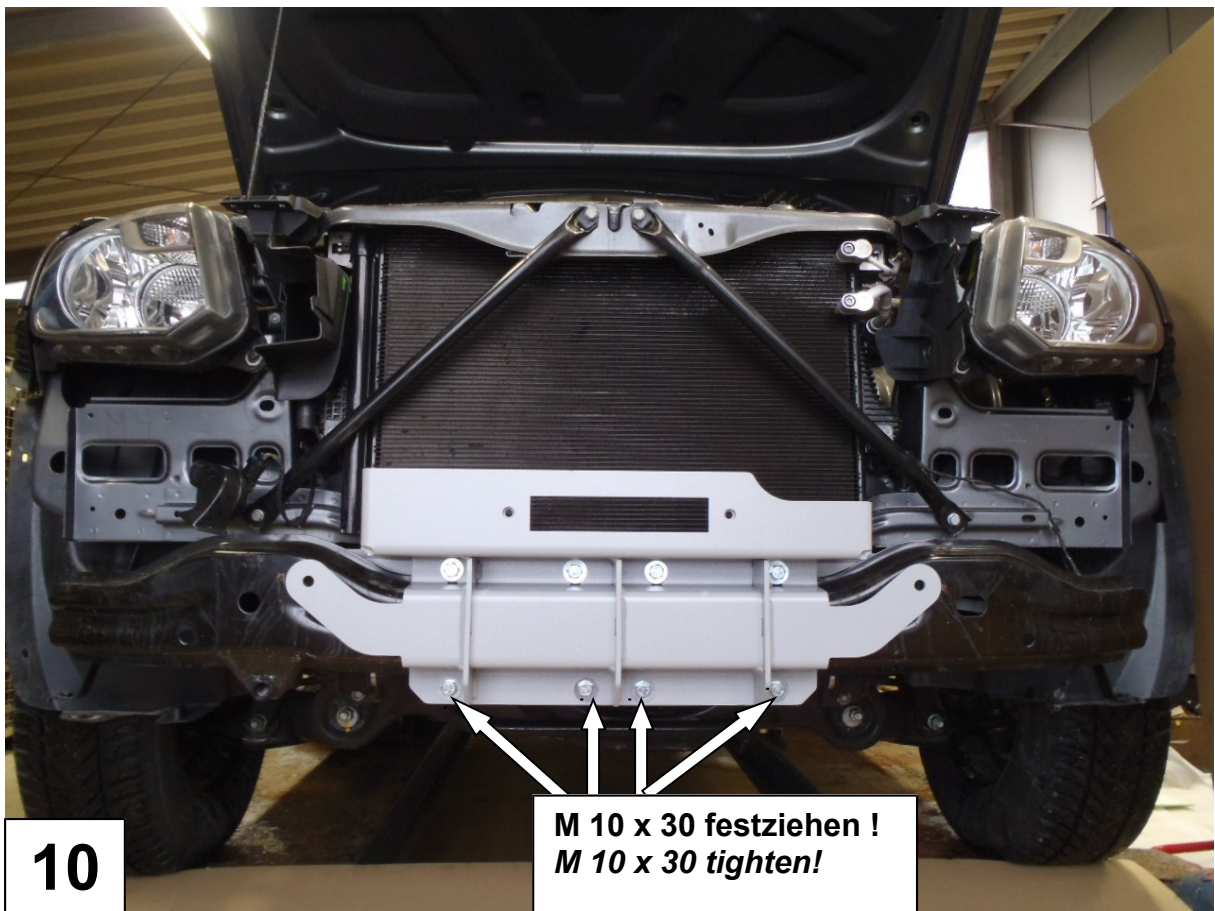

**10**

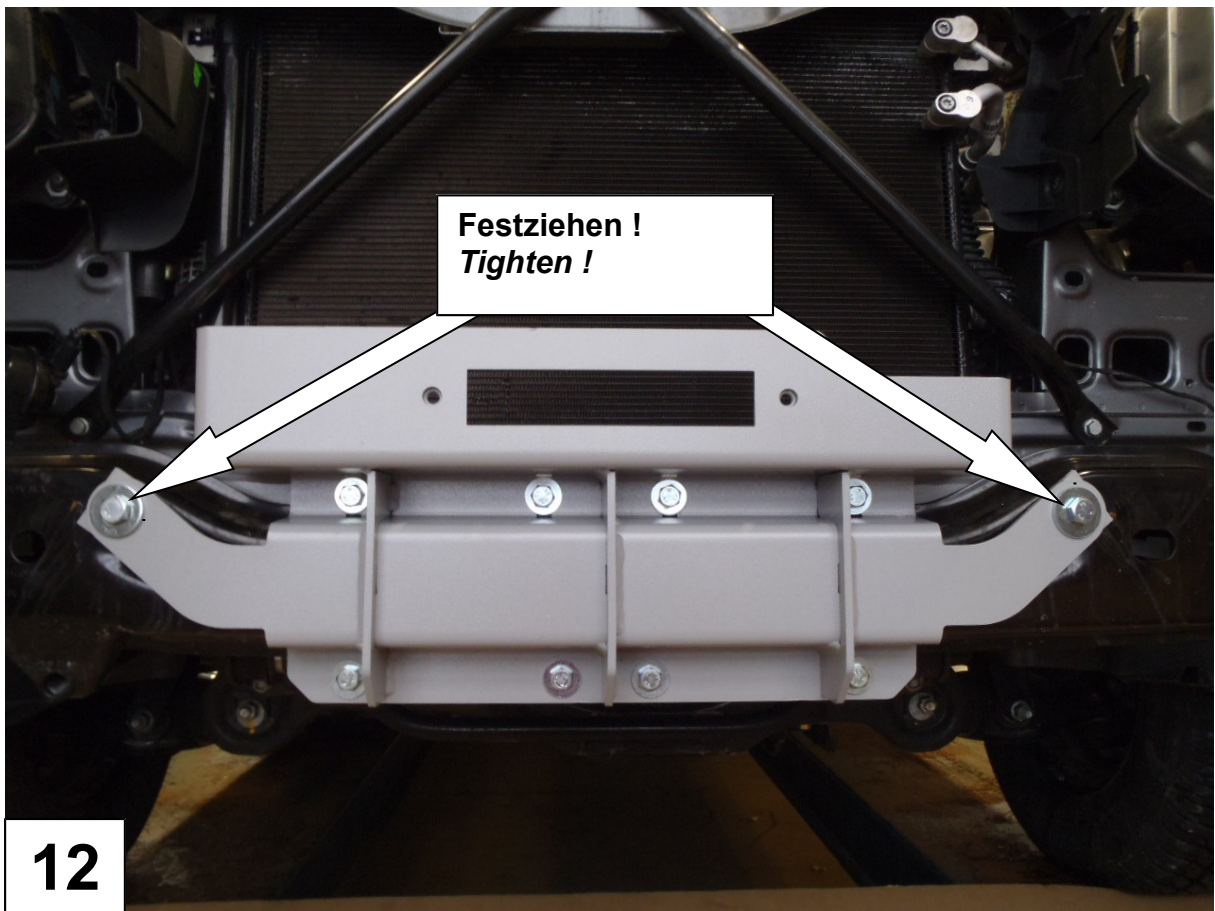
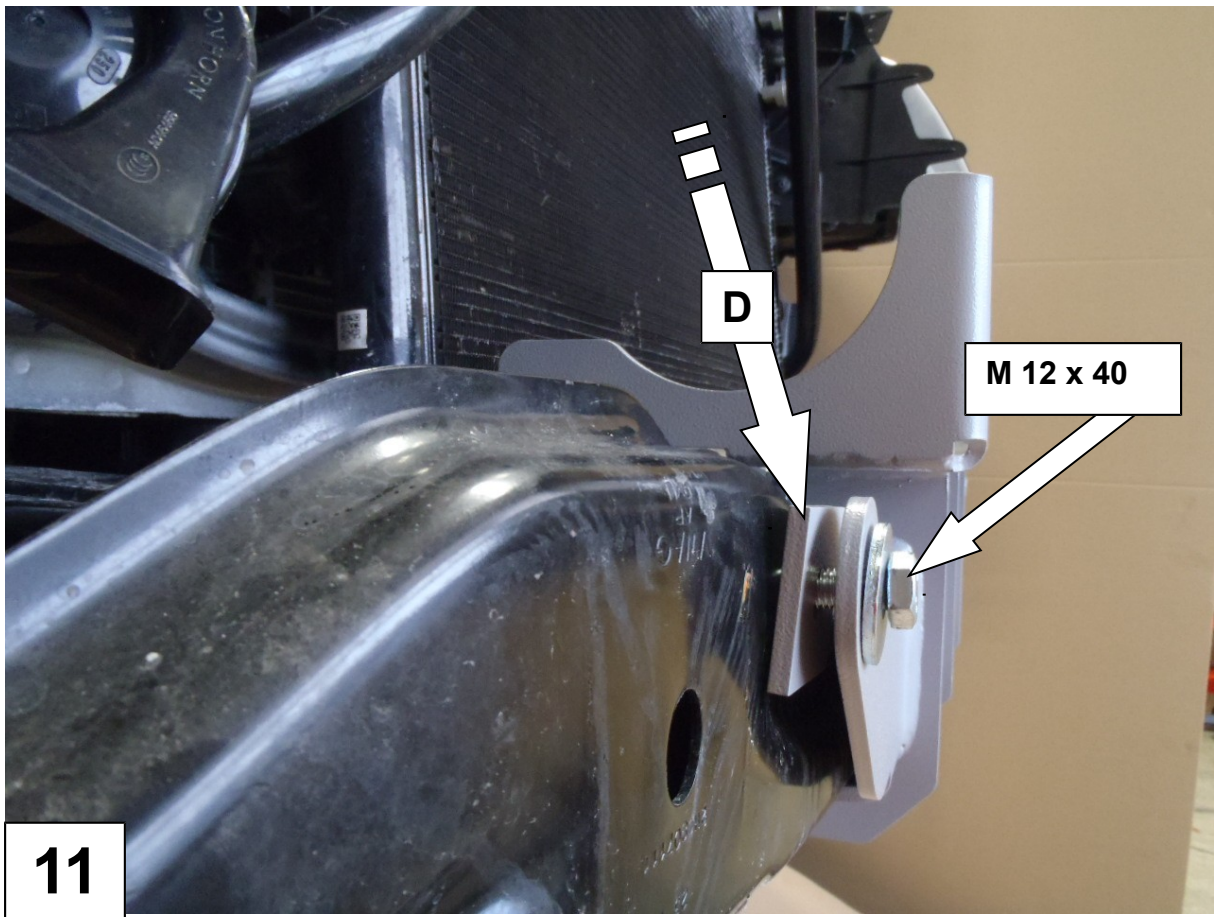



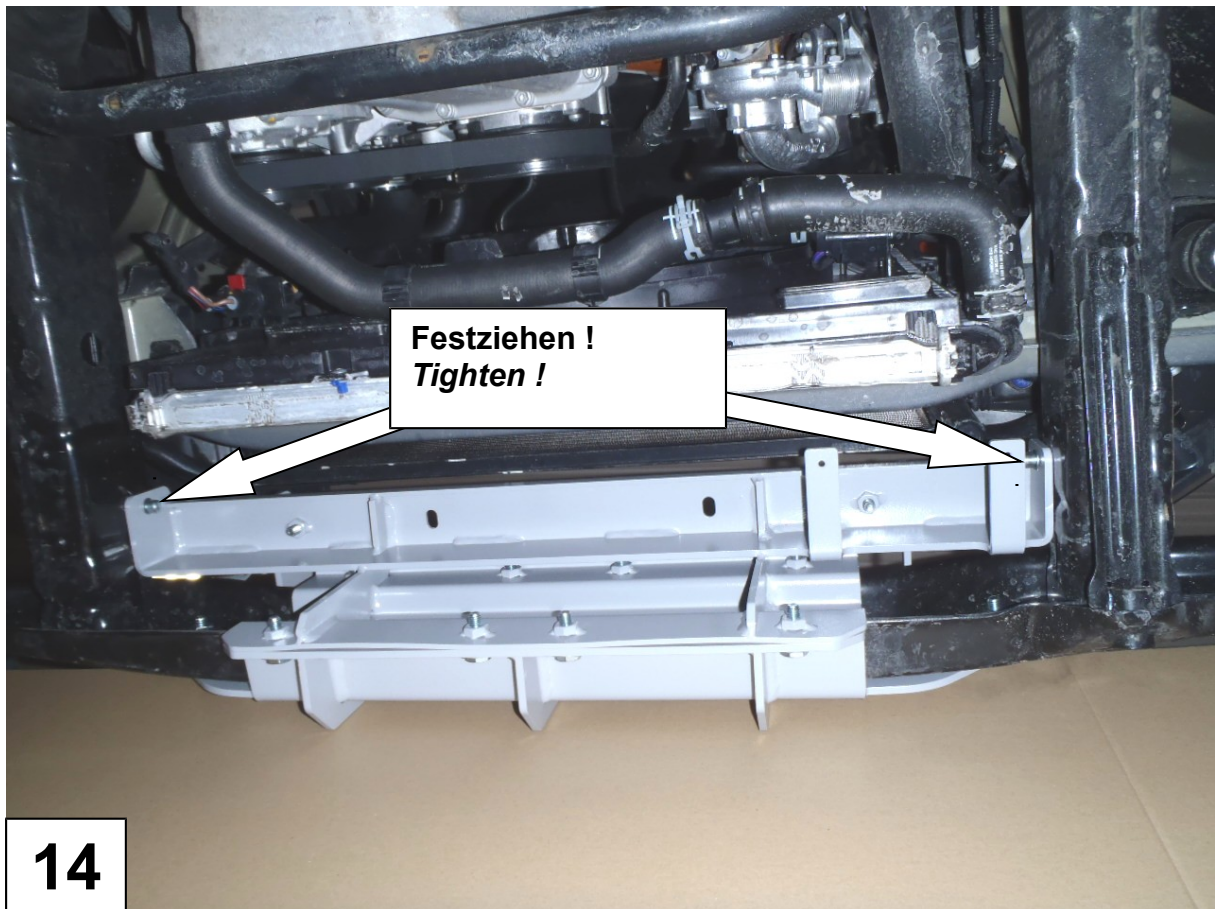
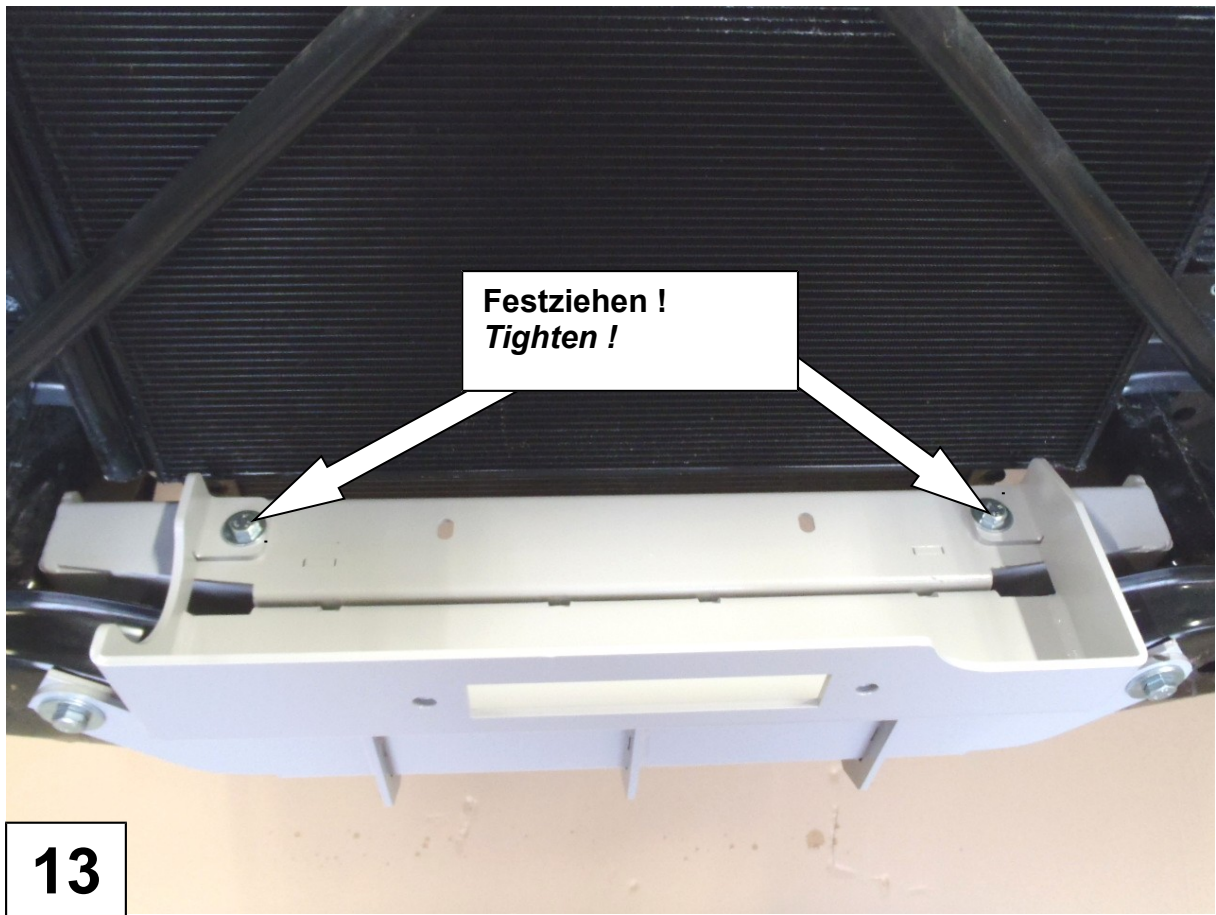

Bei Verwendung einer ZEON-Winde,  
weiter mit Bild 24 !  
*If you want to fit a ZEON-winch go on with  
picture 24 !*

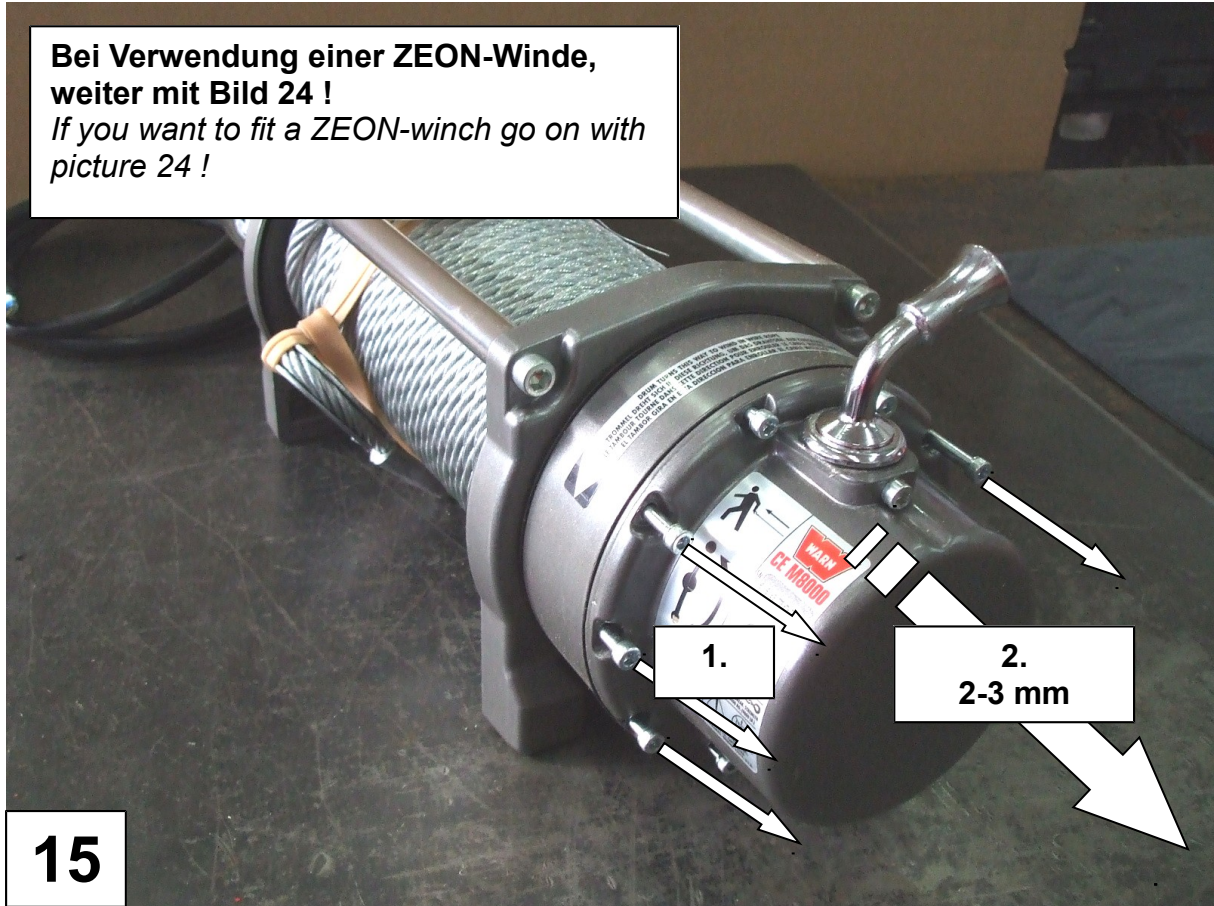

15

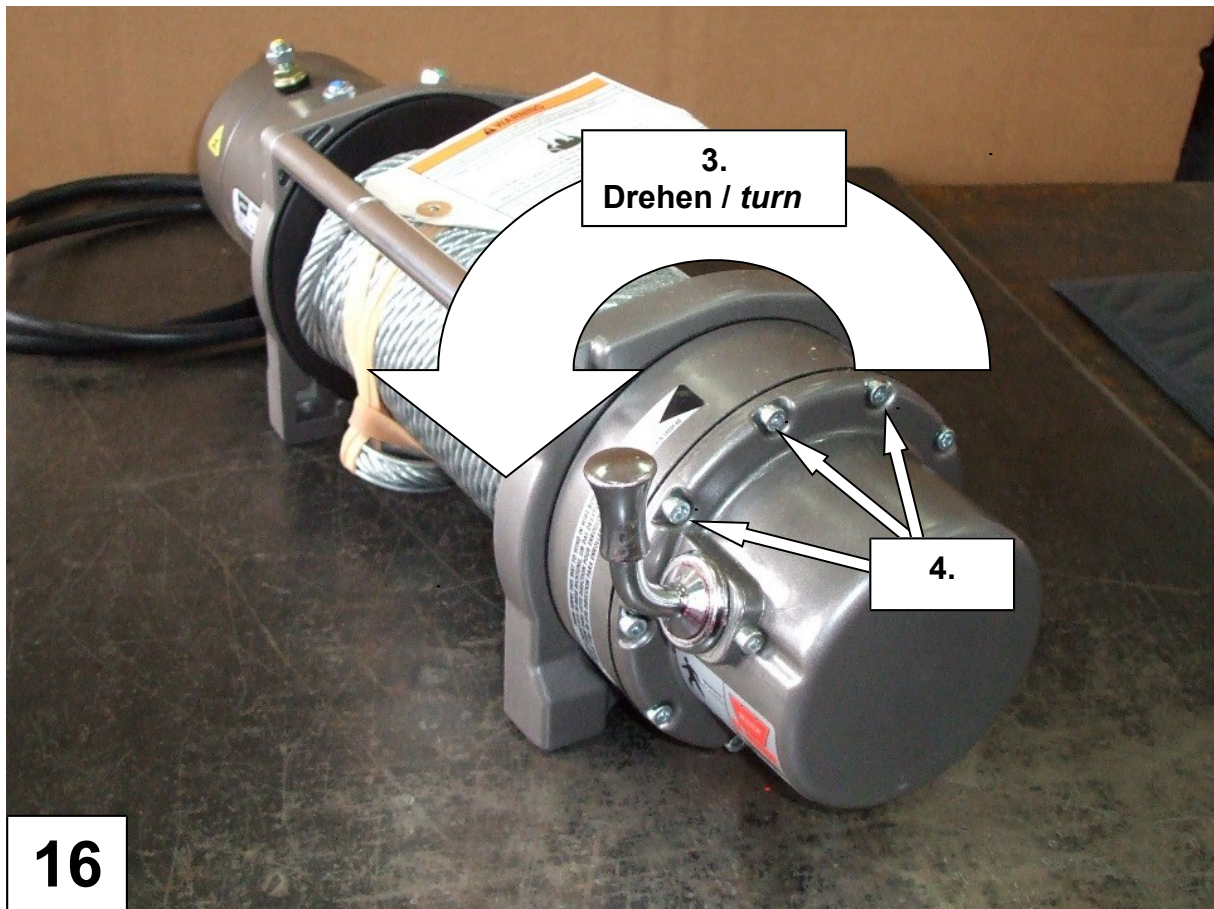

16

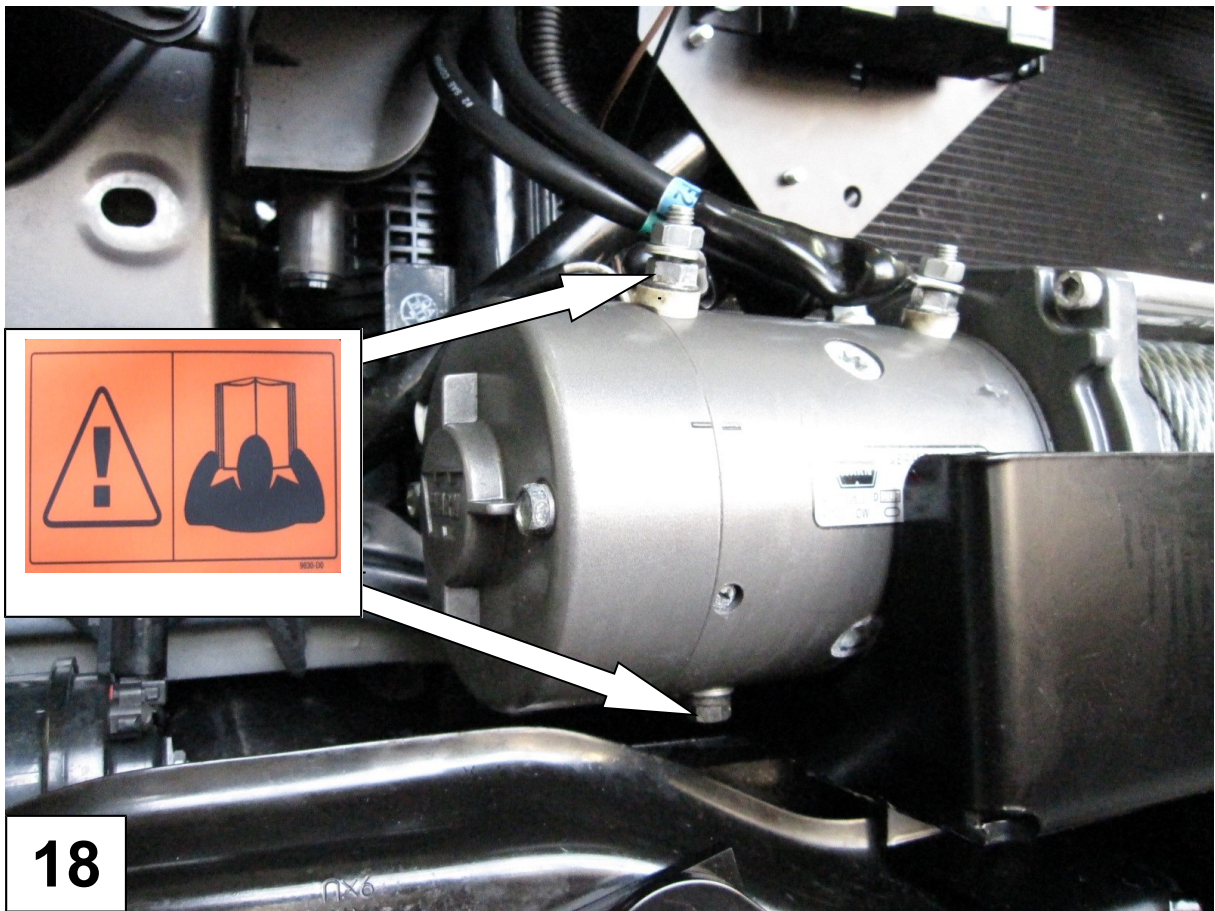
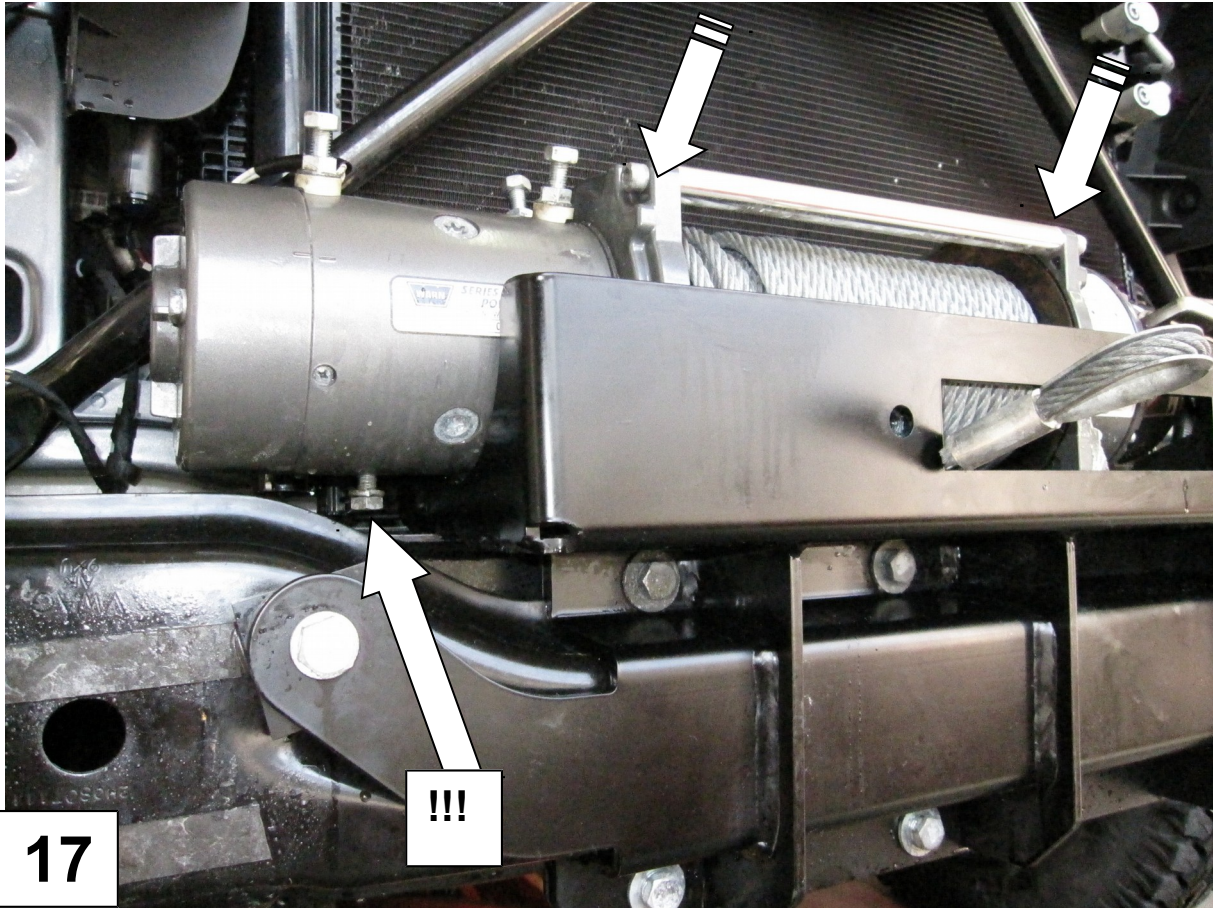

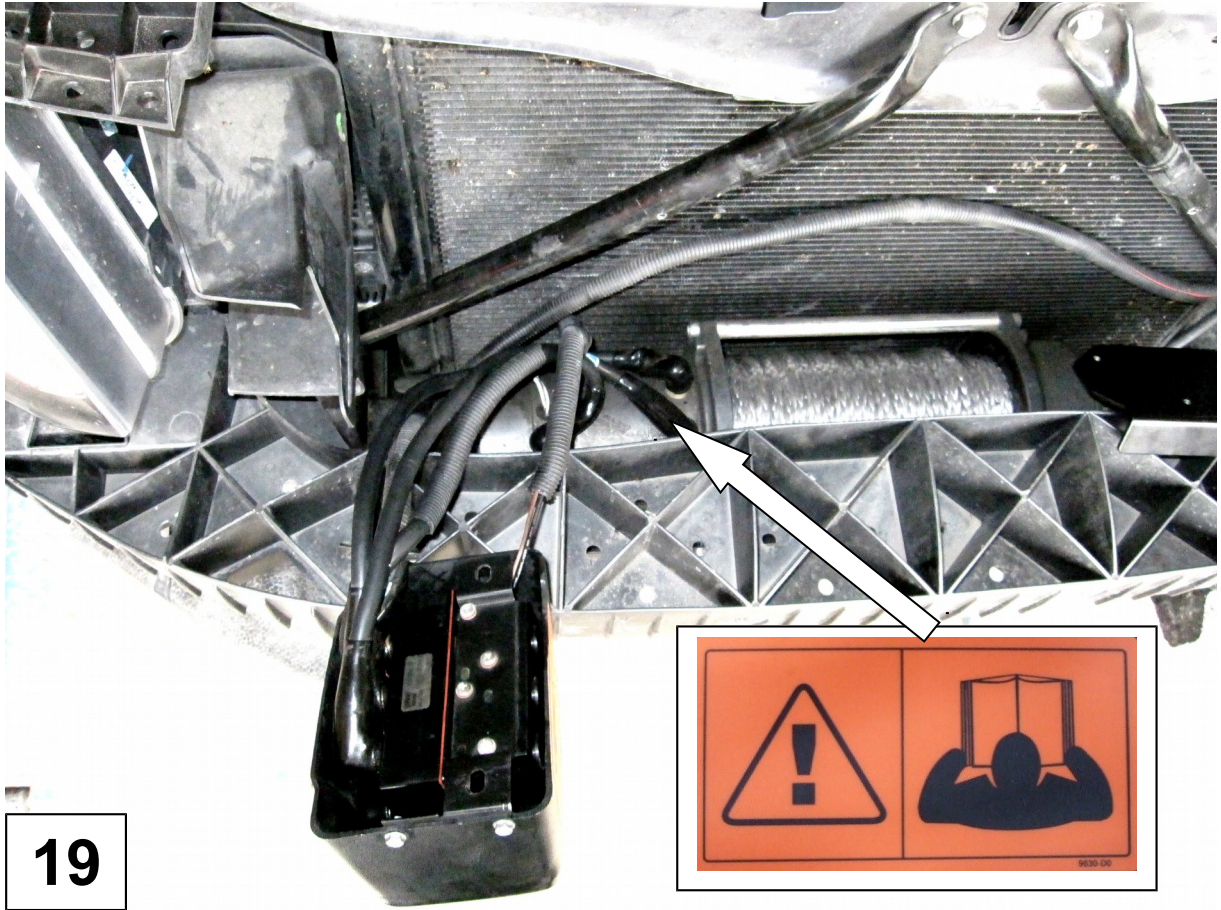

19

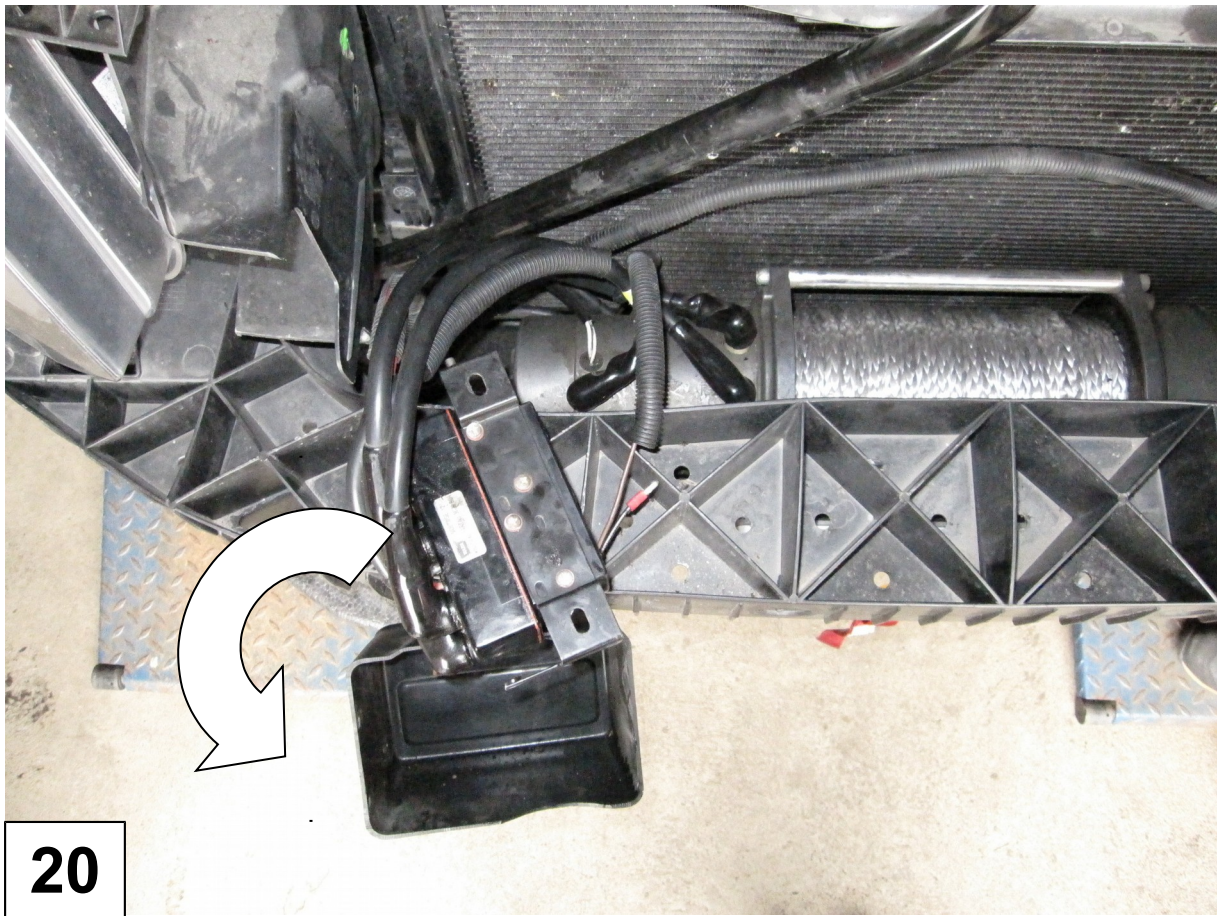

20

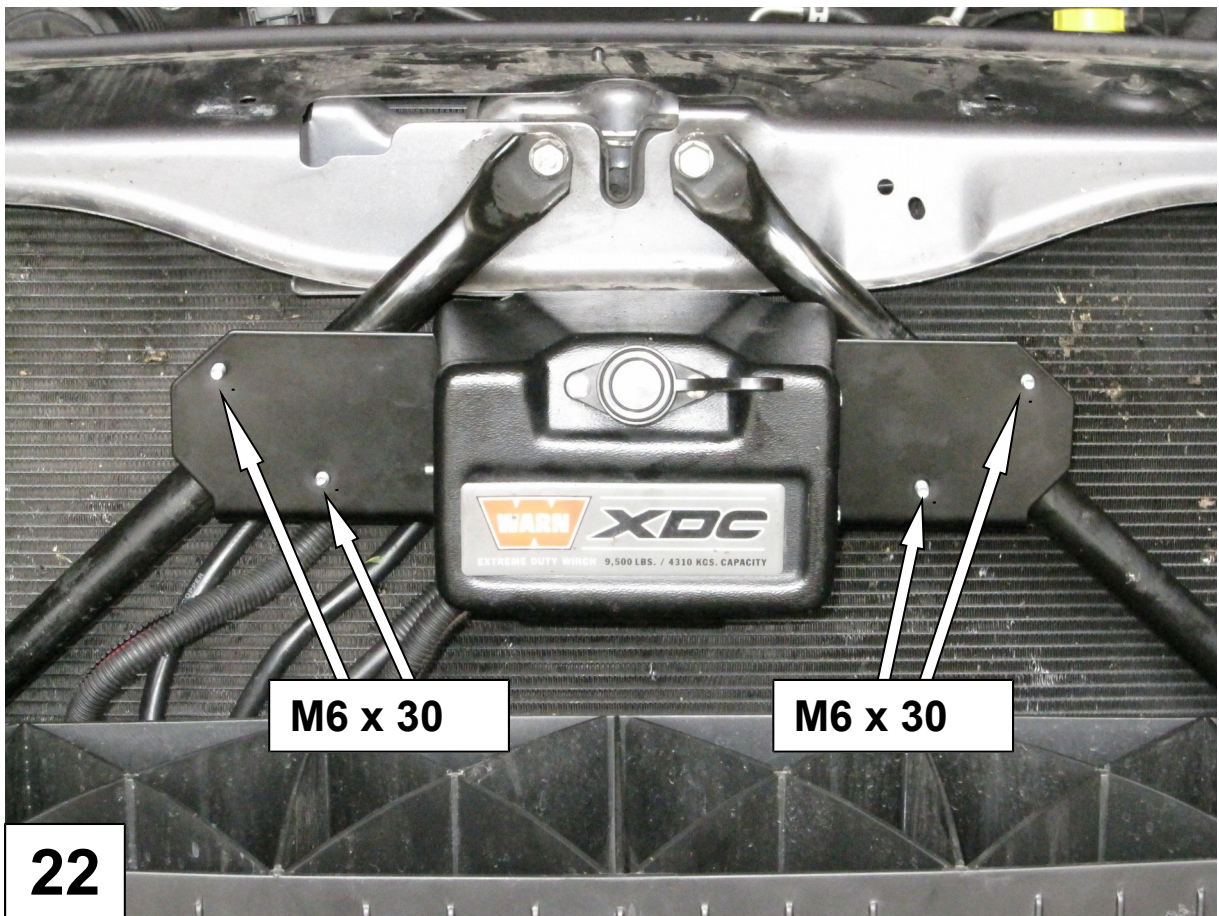
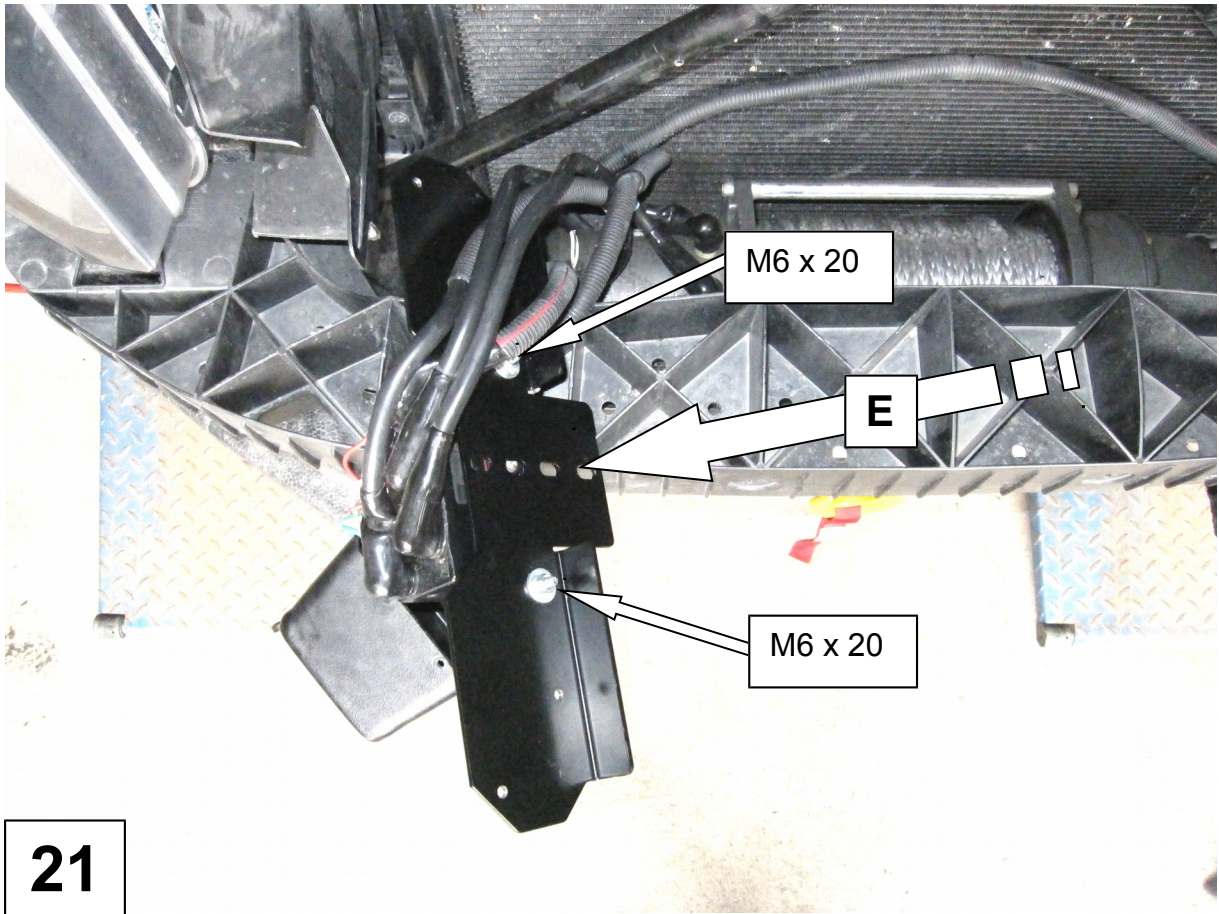

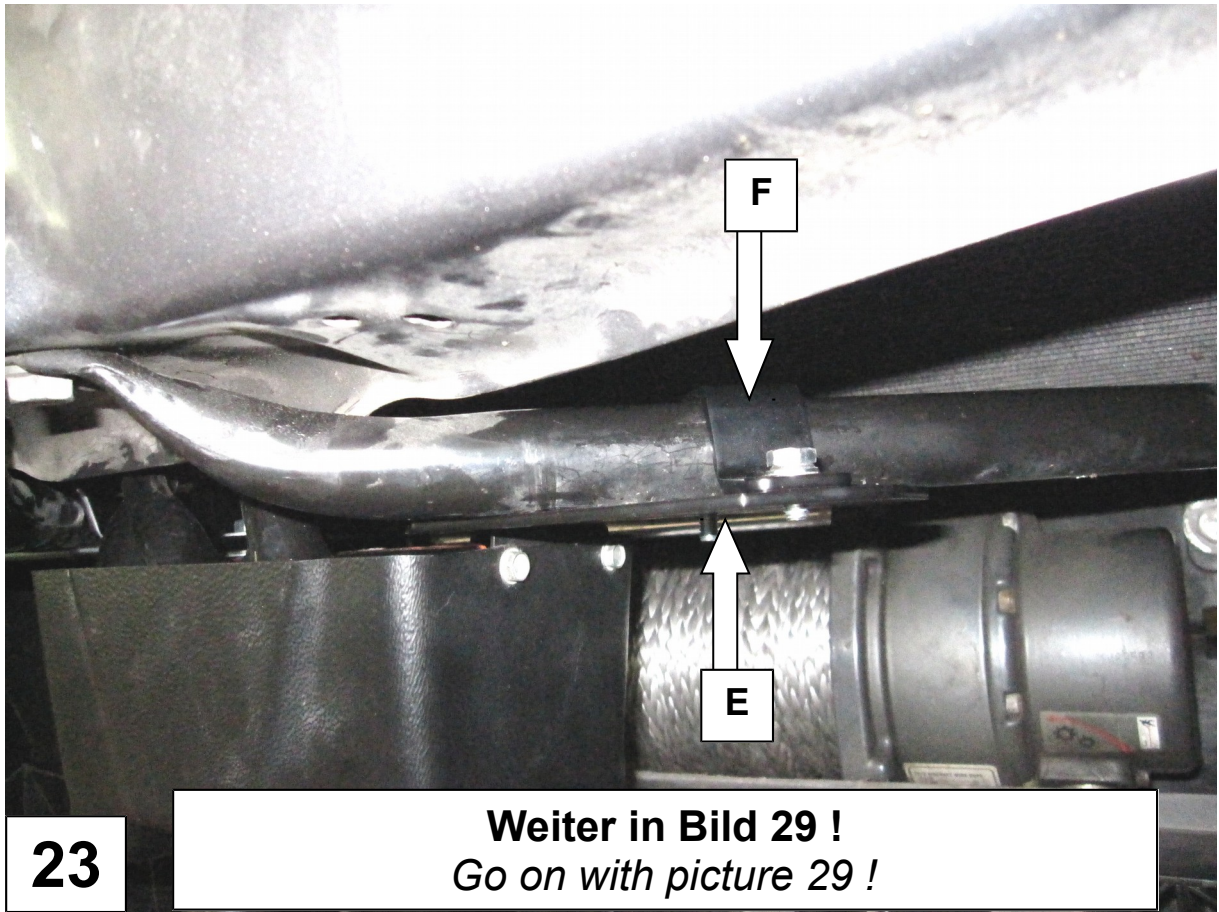

**23**

**Weiter in Bild 29 !**  
*Go on with picture 29 !*

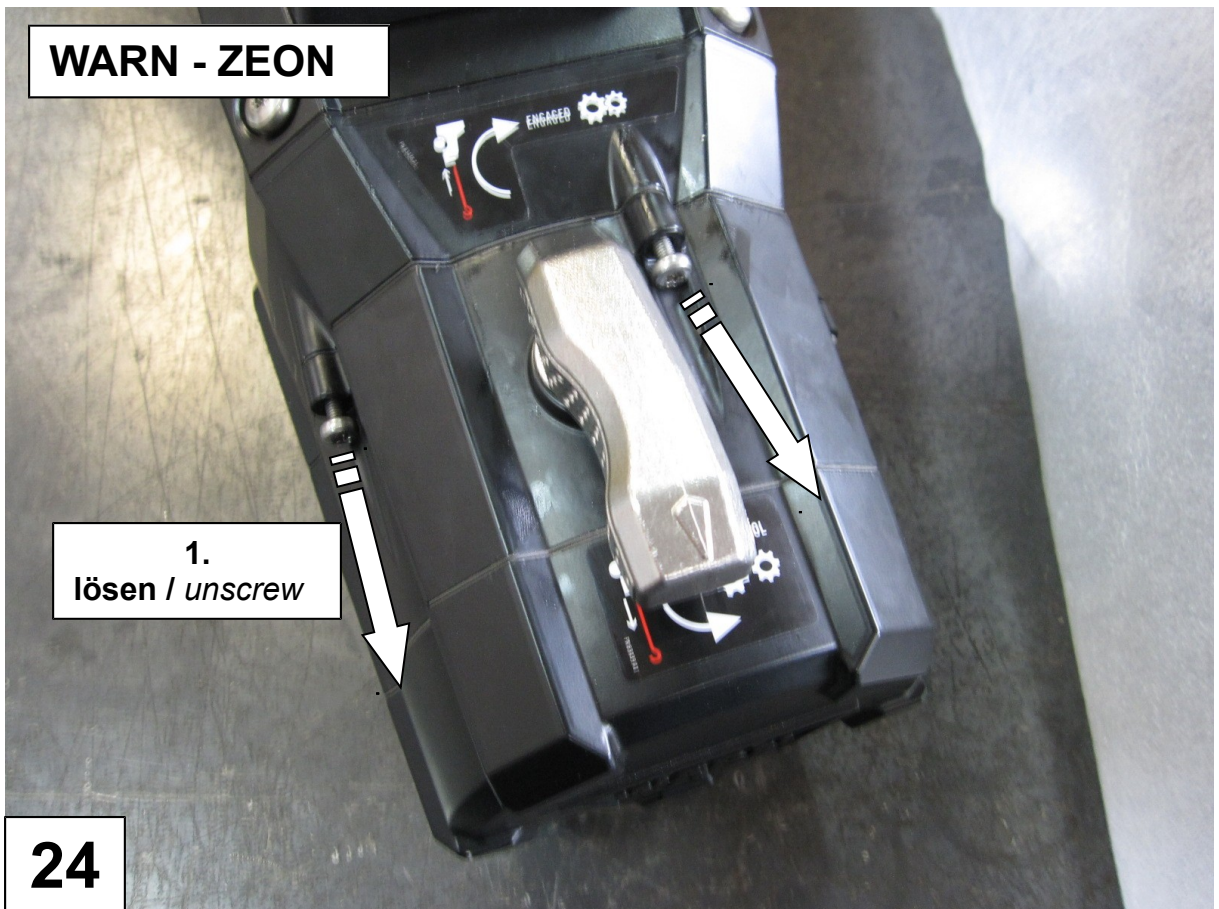

**24**

**WARN - ZEON**

**1.**  
**lösen / unscrew**

WARN - ZEON

2.  
Drehen / turn

25

WARN - ZEON

3.  
festziehen  
tighten

26

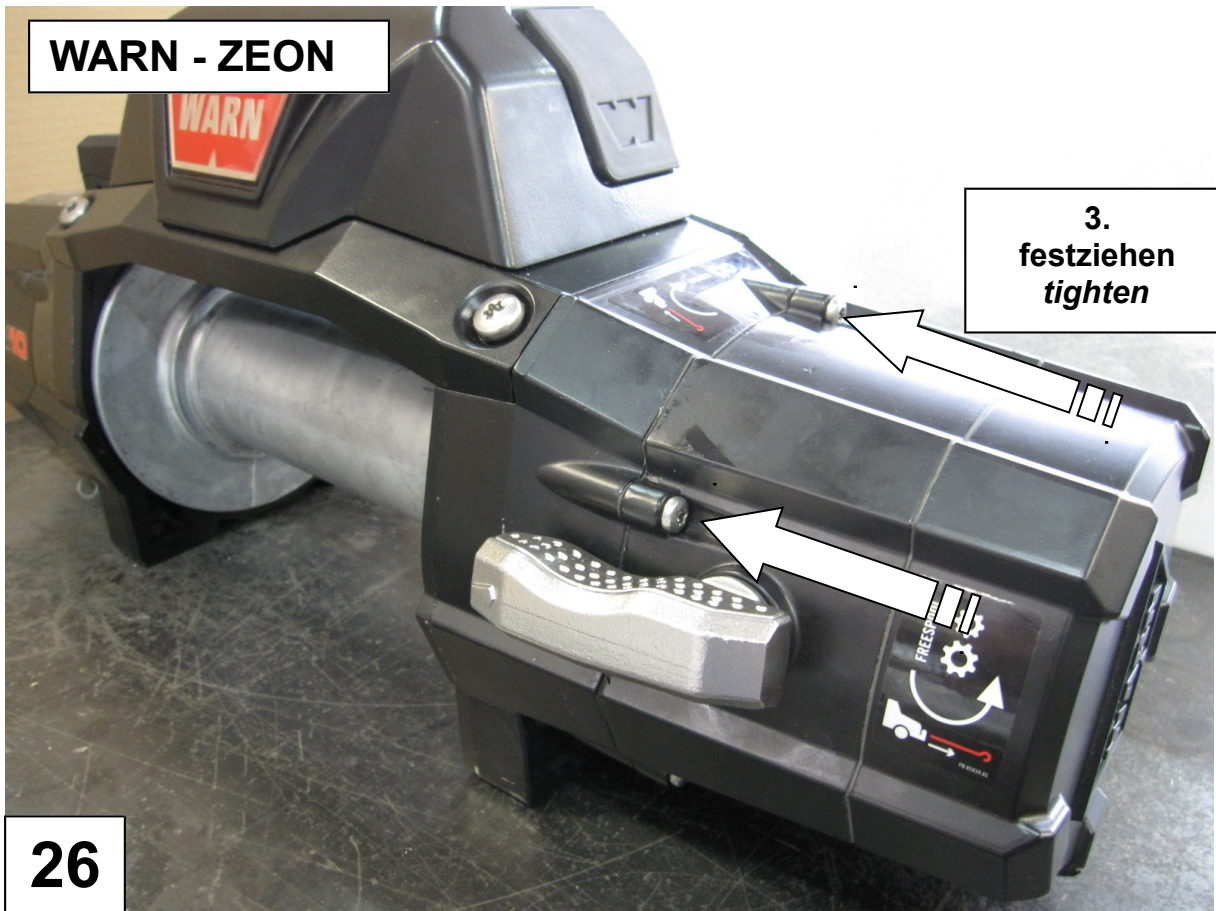
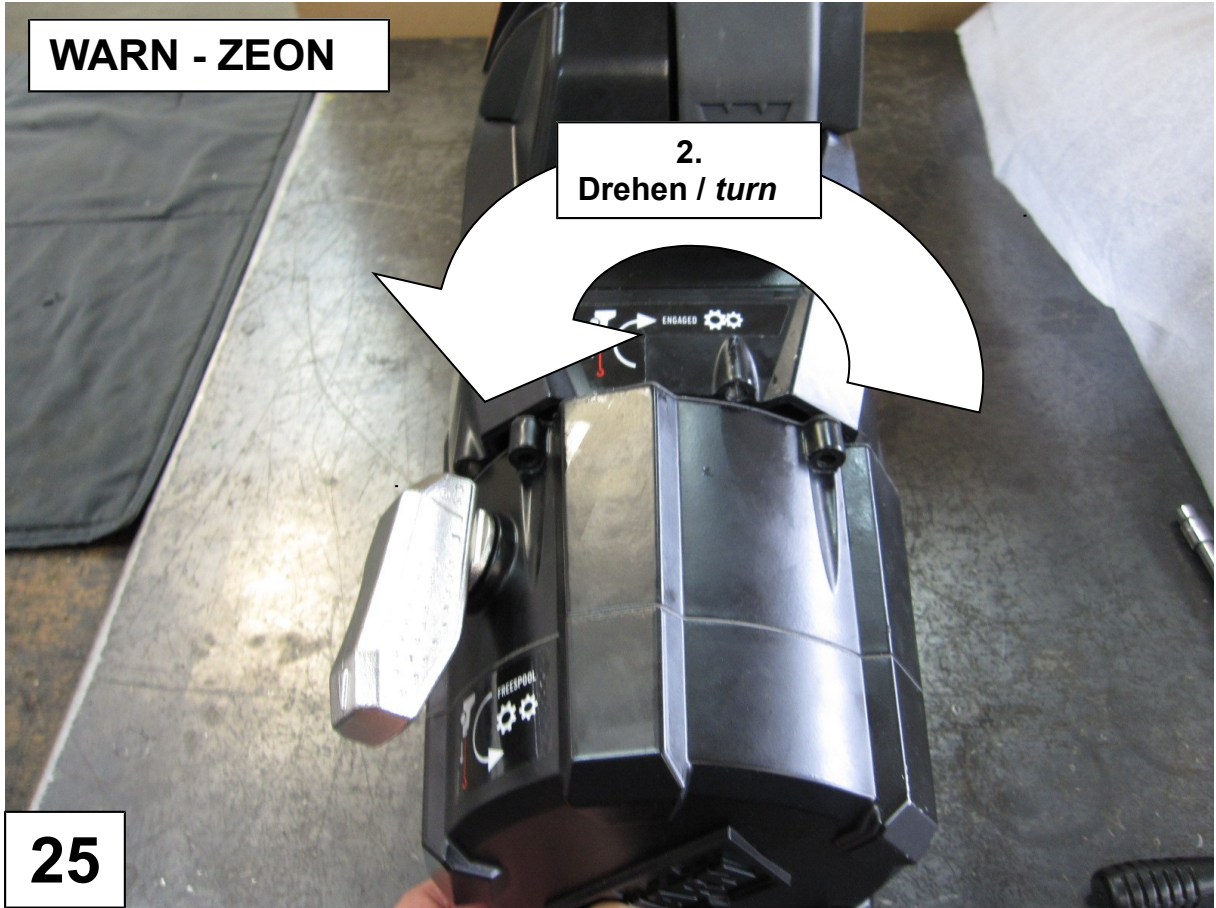

## WARN - ZEON

**Wir empfehlen den  
Einbau der Steckdosen-  
verlängerung 1-90394 !**

*We recommend the  
installation of socket  
extension kit 1-90394 !*



**27**

## WARN - ZEON

**Befestigen sie die Steckdose des Verlängerungskits an einem platz ihrer Wahl.**

*Fit the socket of the extension kit to a position of your choice !*



**28**



# WARN - ZEON

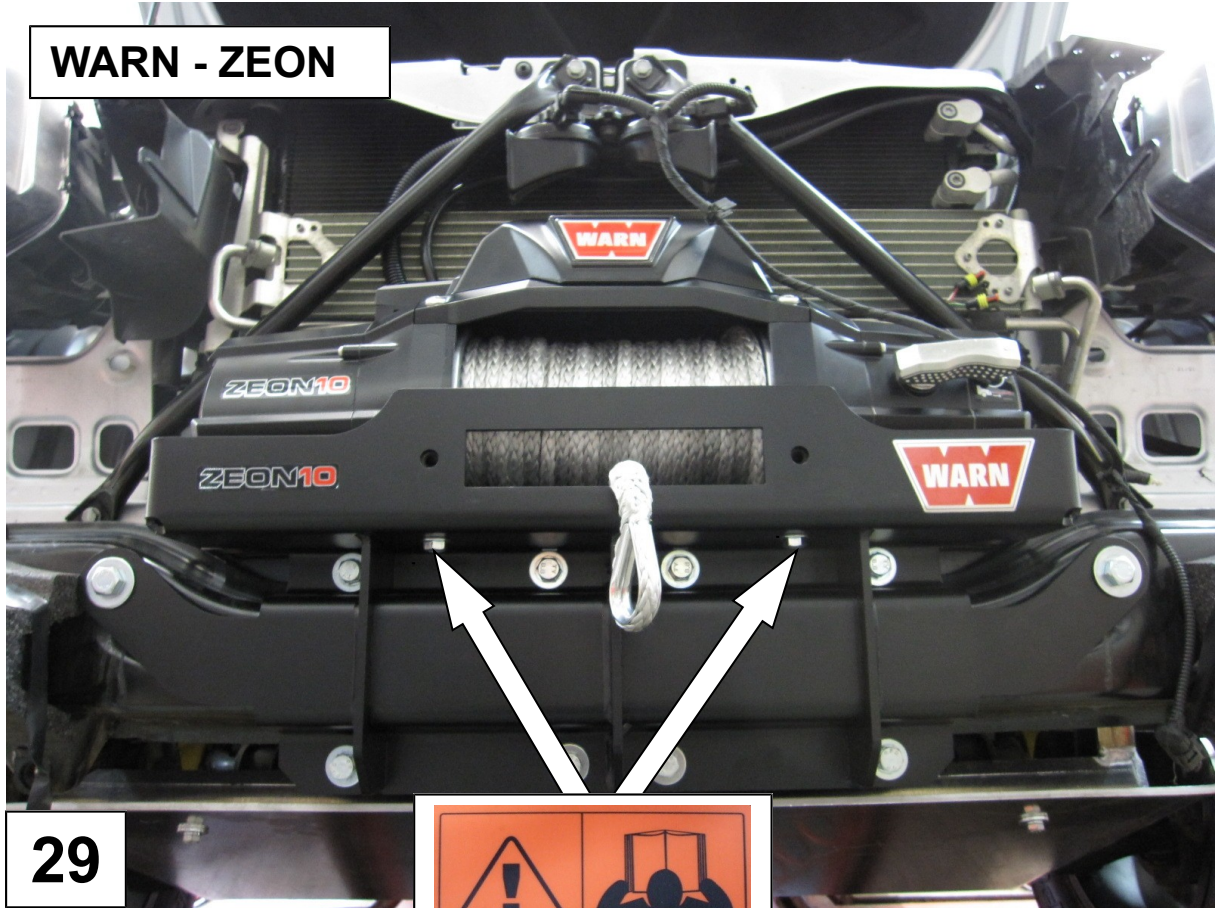

29



Befestigen Sie die Winde ,wie in der Bedienungsanleitung beschrieben !

*Fix the winch as described in the winch manual!*

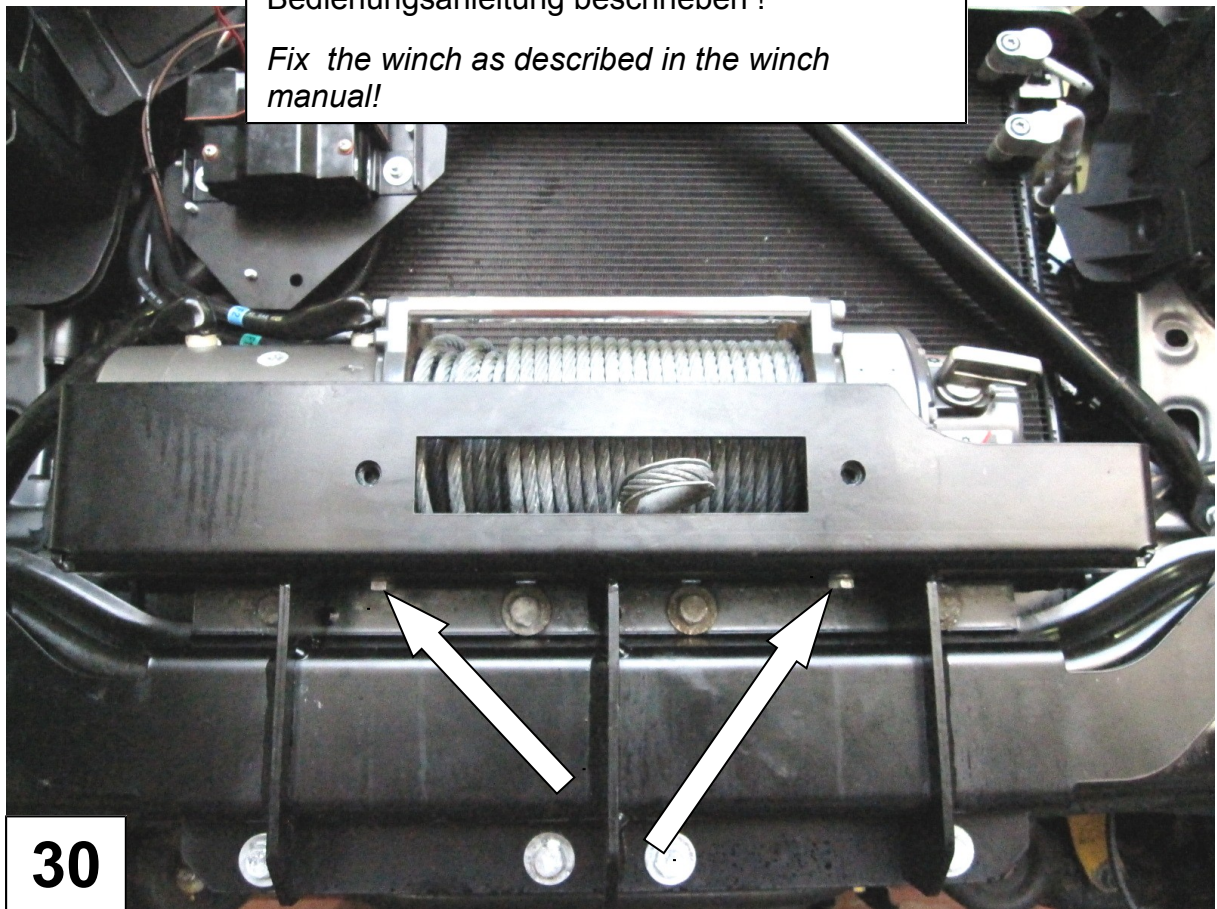

30

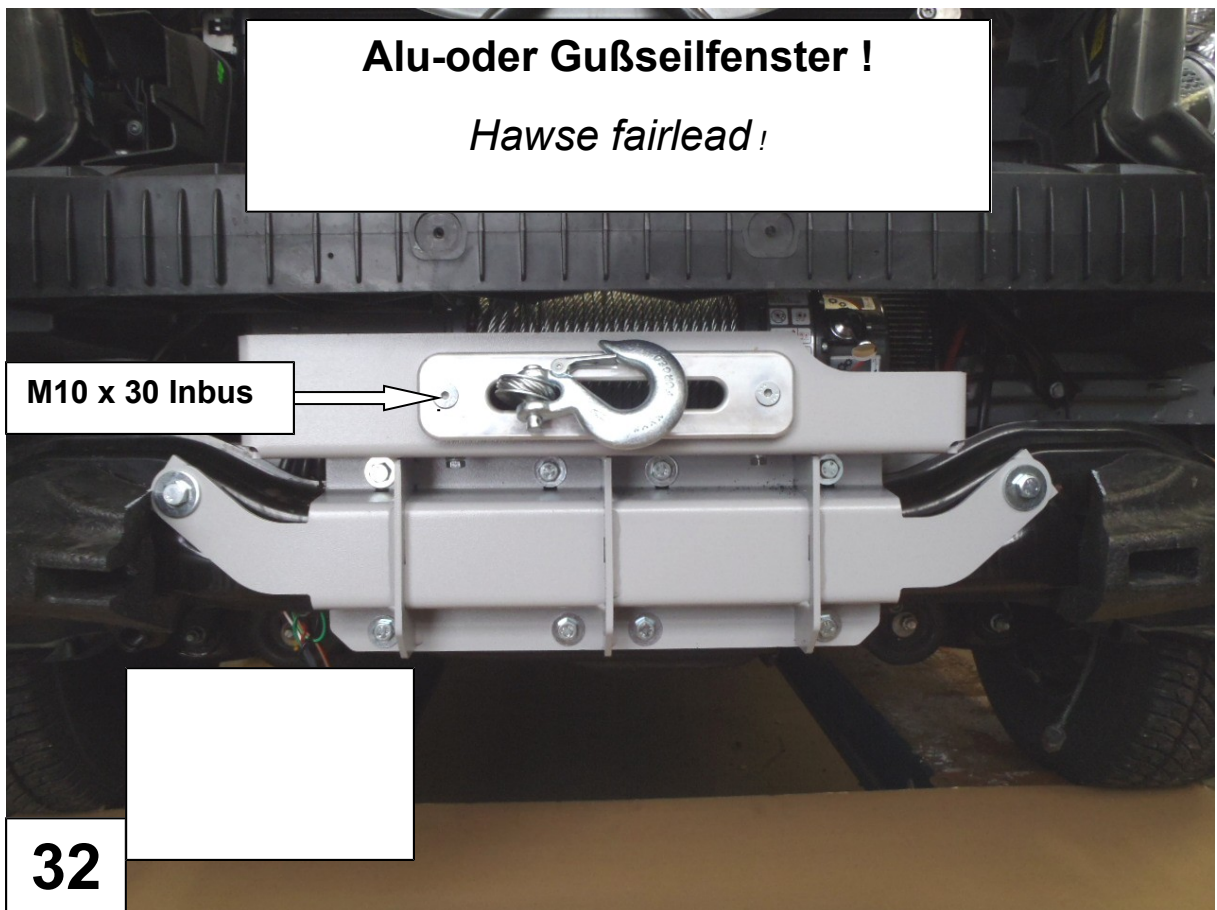
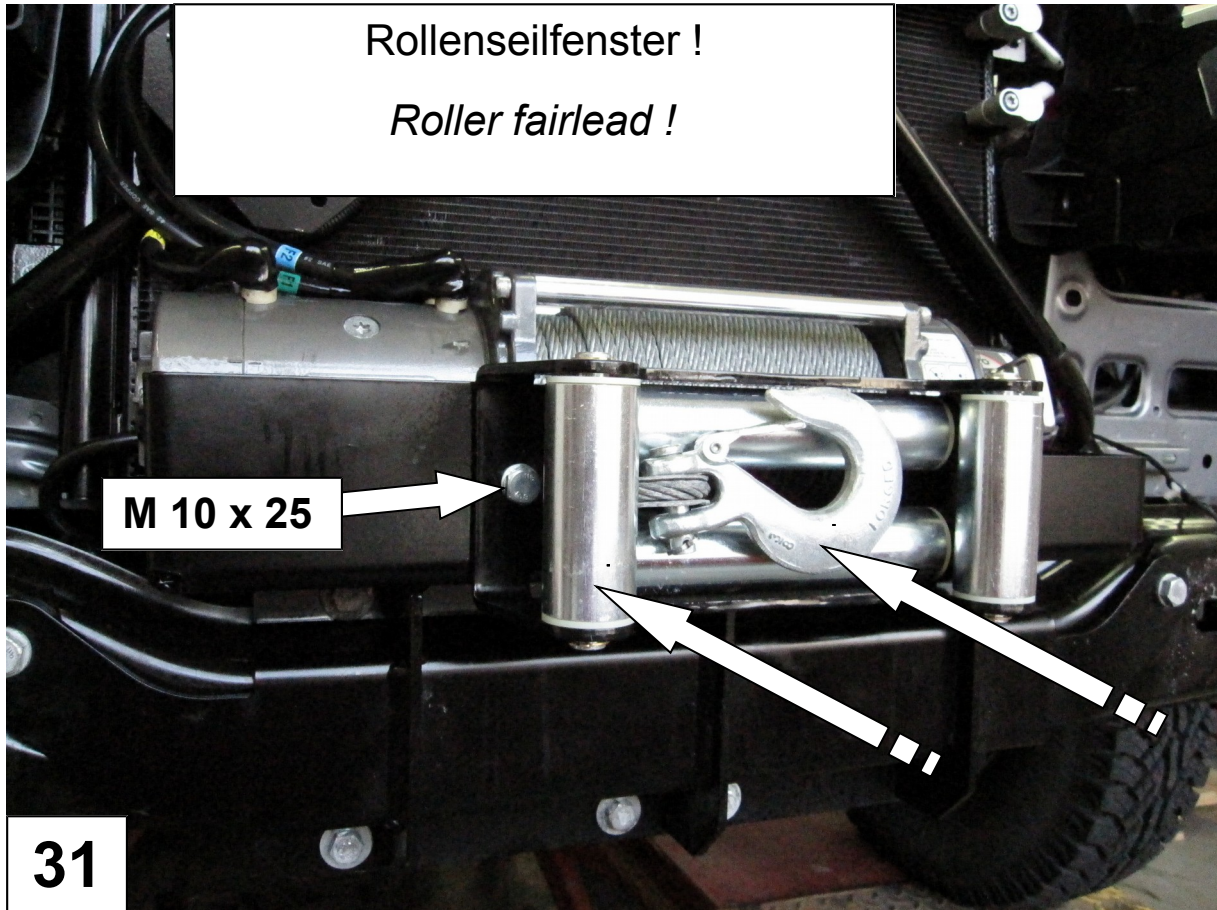

Bei Verwendung einer ZEON-Winde,  
weiter mit Bild 29 !  
*If you want to fit a ZEON-winch go on with  
picture 29 !*

Ausschneiden siehe auch Bild 26 !  
*Cut out, please have a look at pict.26!*

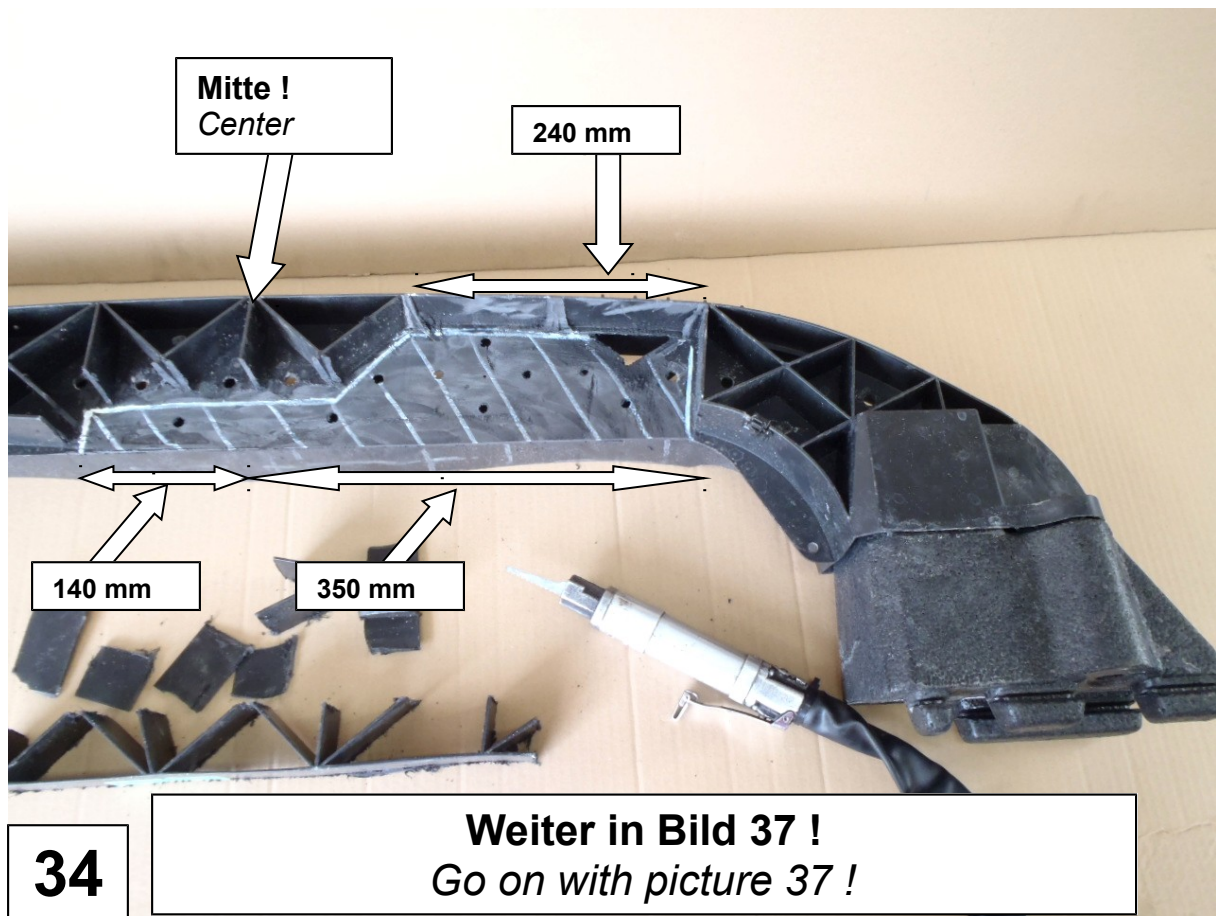
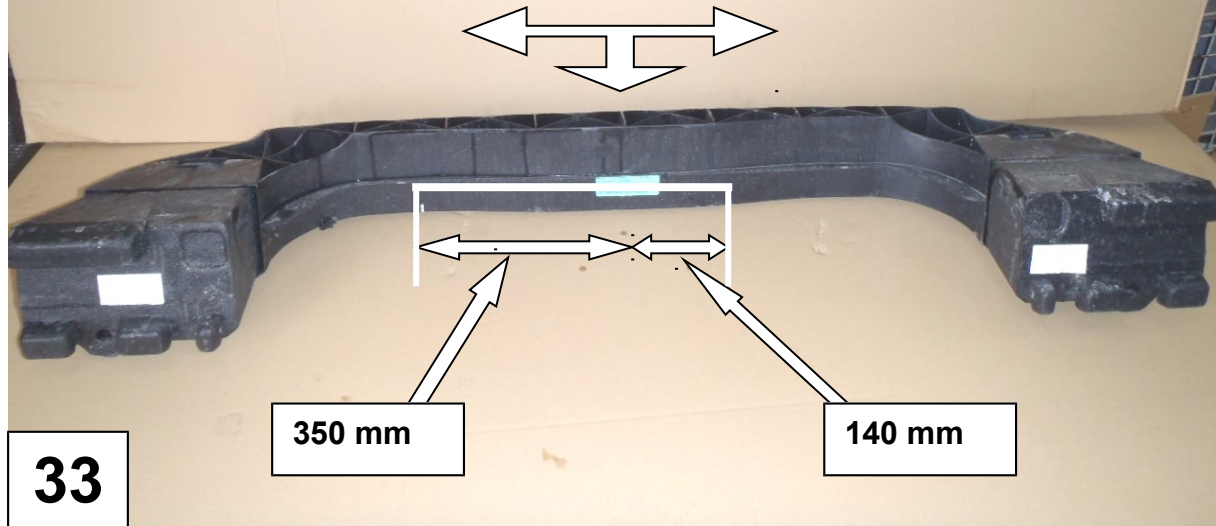

**WARN - ZEON**

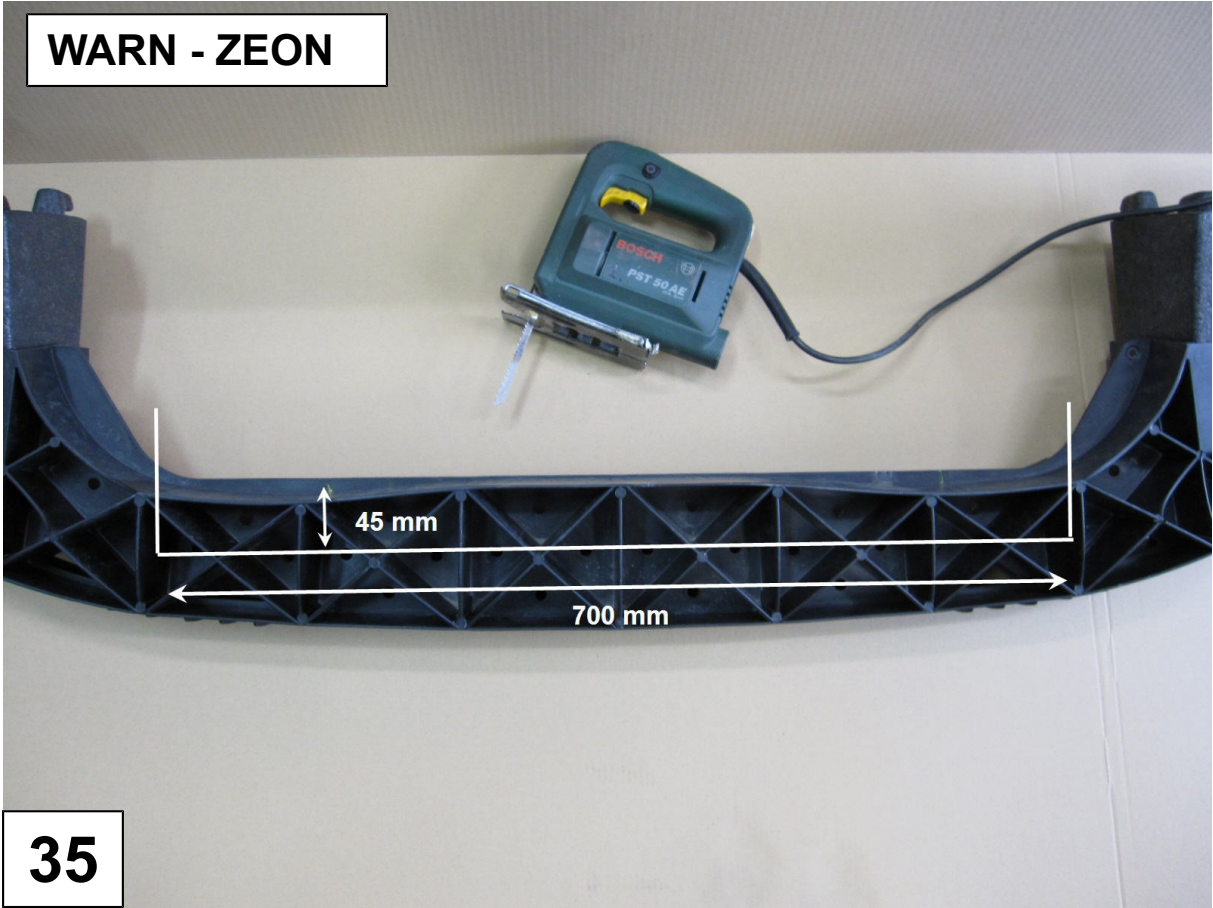

**35**

**WARN - ZEON**

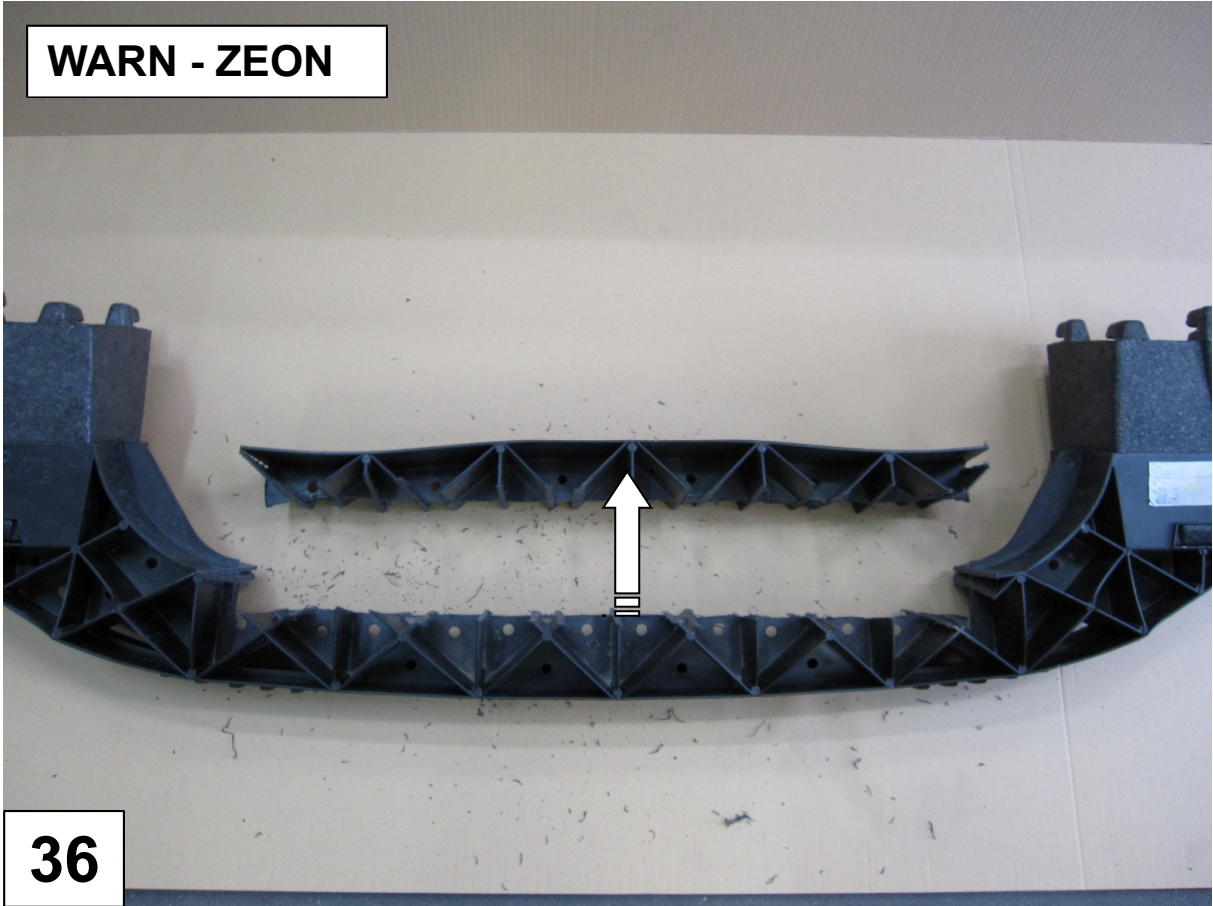

**36**

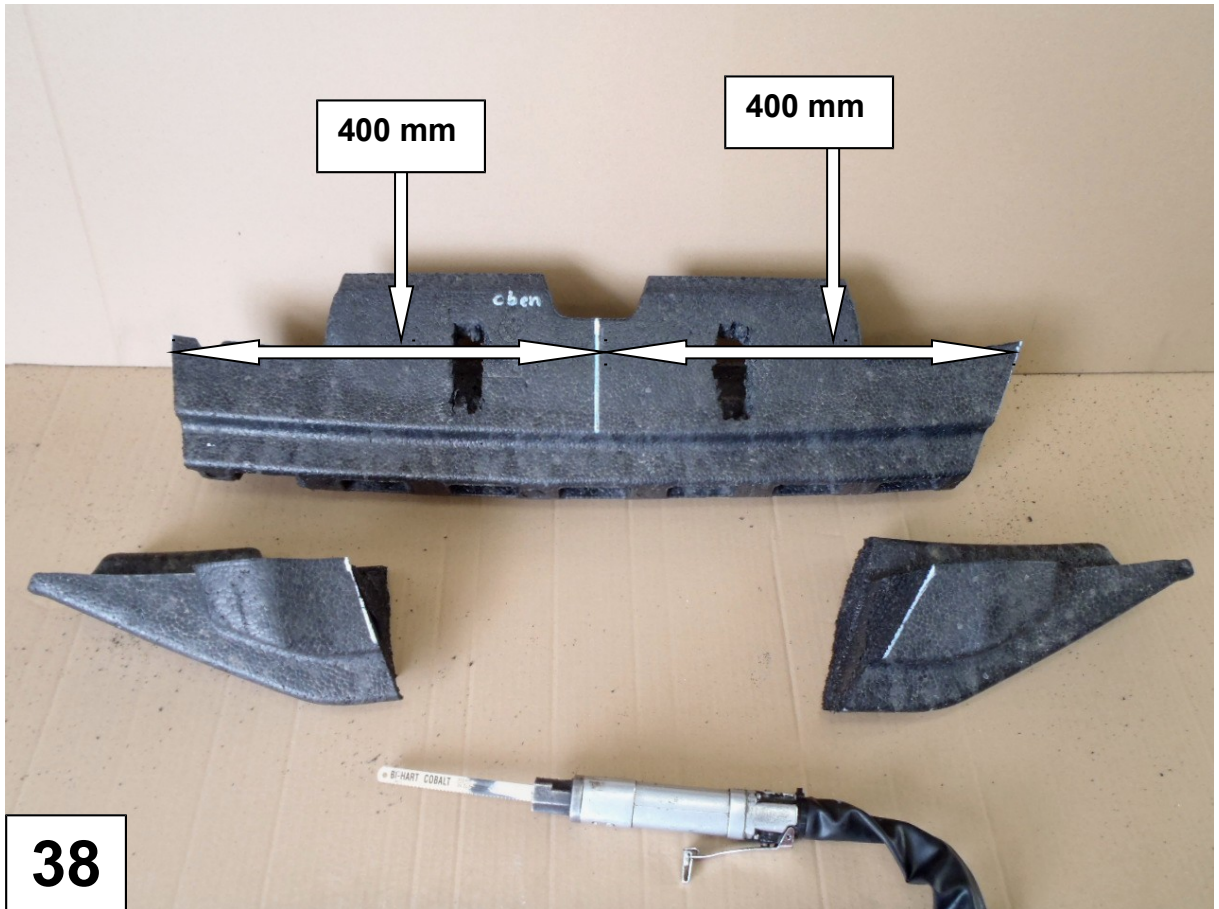



**Ausschnitt für Aluminium –  
oder Gusseifenfenster !  
„Trendline“ Stoßfänger**

*Cutout for hawse fairlead !  
„Trendline“ bumper*

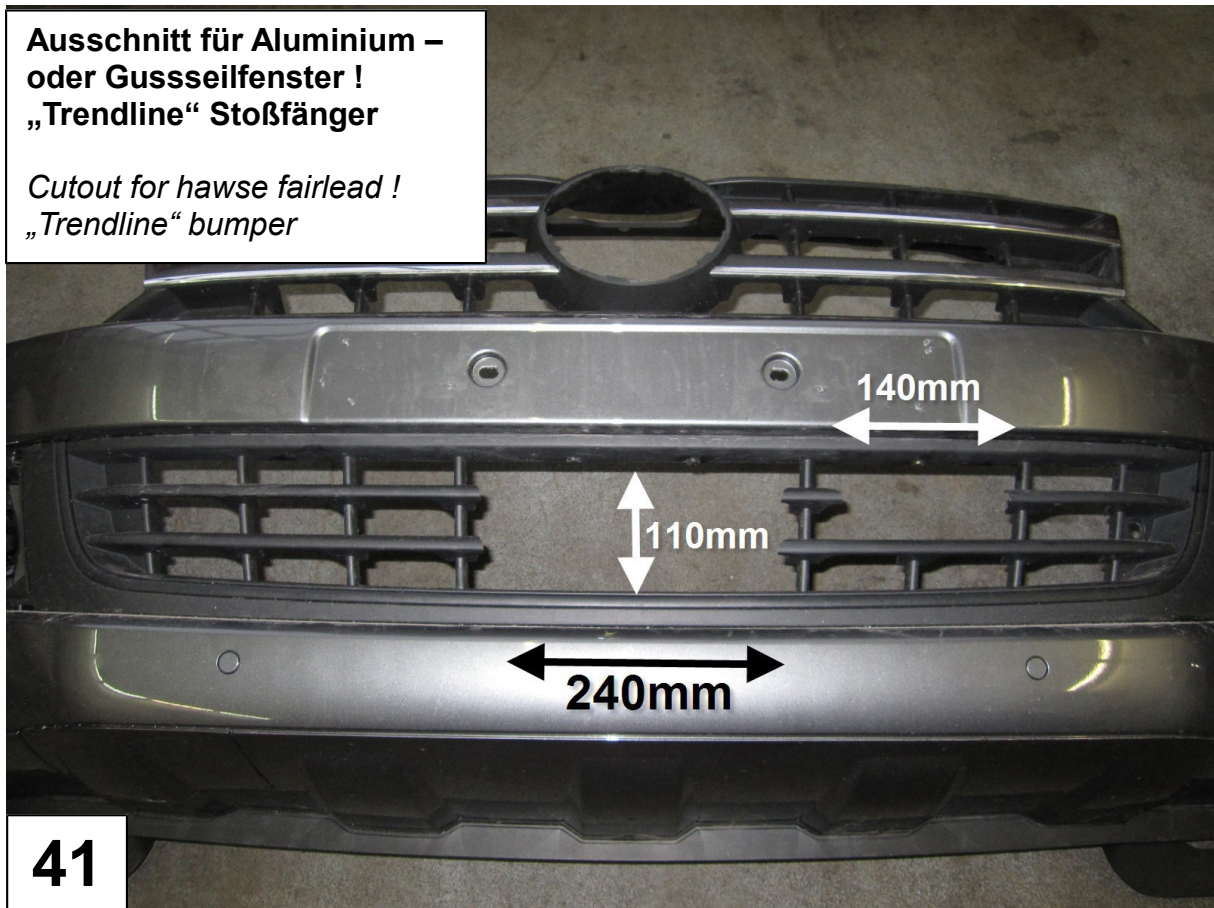

**WARN - ZEON**

**Ausschnitt für Aluminium –  
oder Gusseifenfenster !  
„Trendline“ Stoßfänger**

*Cutout for hawse fairlead !  
„Trendline“ bumper*



**Ausschnitt für  
Rollenseilfenster !  
„Basic line“ Stoßfänger**

*Cutout for roller- fairlead !  
„Basic line“ bumper*



**Ausschnitt für  
Rollenseilfenster !  
„Highline“ Stoßfänger**

*Cutout for roller- fairlead !  
„Highline“ bumper*

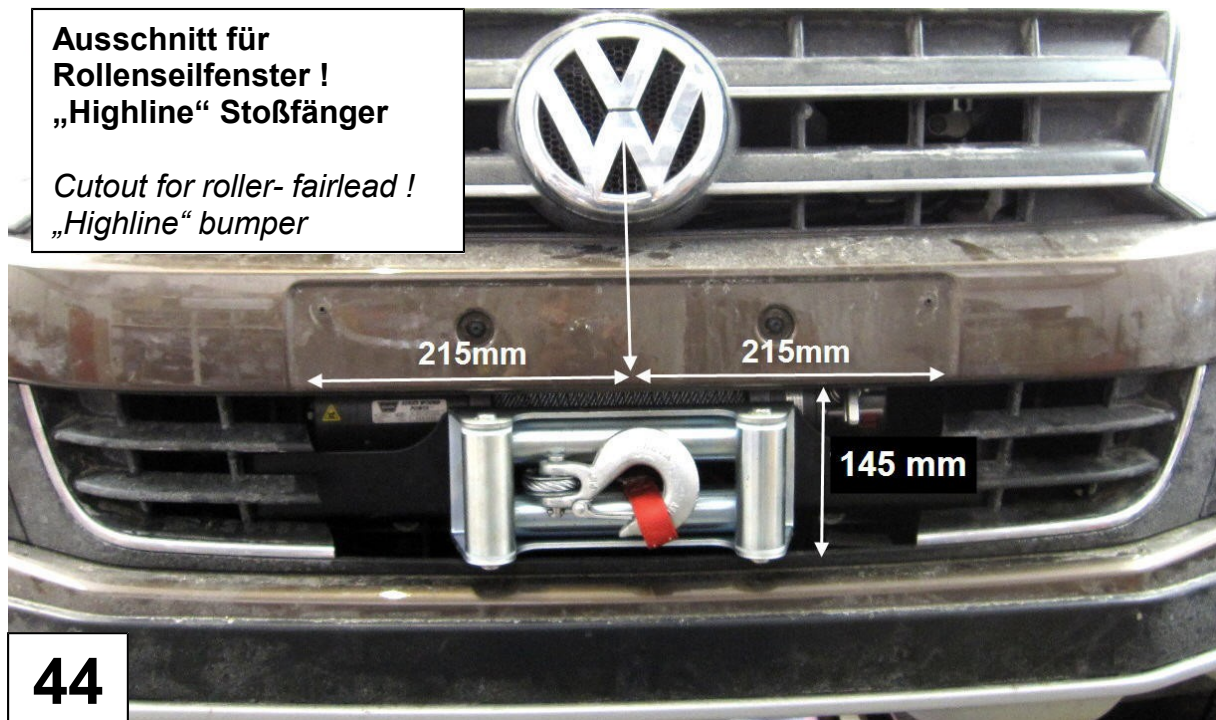



**WARN - ZEON**



**45**

**WARN  
XDC + M 8000**



**46**

**WARN**  
**XDC + M 8000**

Original  
*original*

Bearbeitet  
*modified*

**47**

**WARN**  
**XDC + M 8000**

12 mm

**48**

**WARN  
XDC + M 8000**

Abrunden  
*round off*

**49**

**WARN  
XDC + M 8000**

**TAUBENREUTHER**

**50**

**WARN**  
**XDC + M 8000**



**51**

**WARN**  
**XDC + M 8000**



**52**

VW Amarok  
Rollenseilfensterabdeckung 15-899 zuschneiden!  
*Modify the roller fairlead cover !*



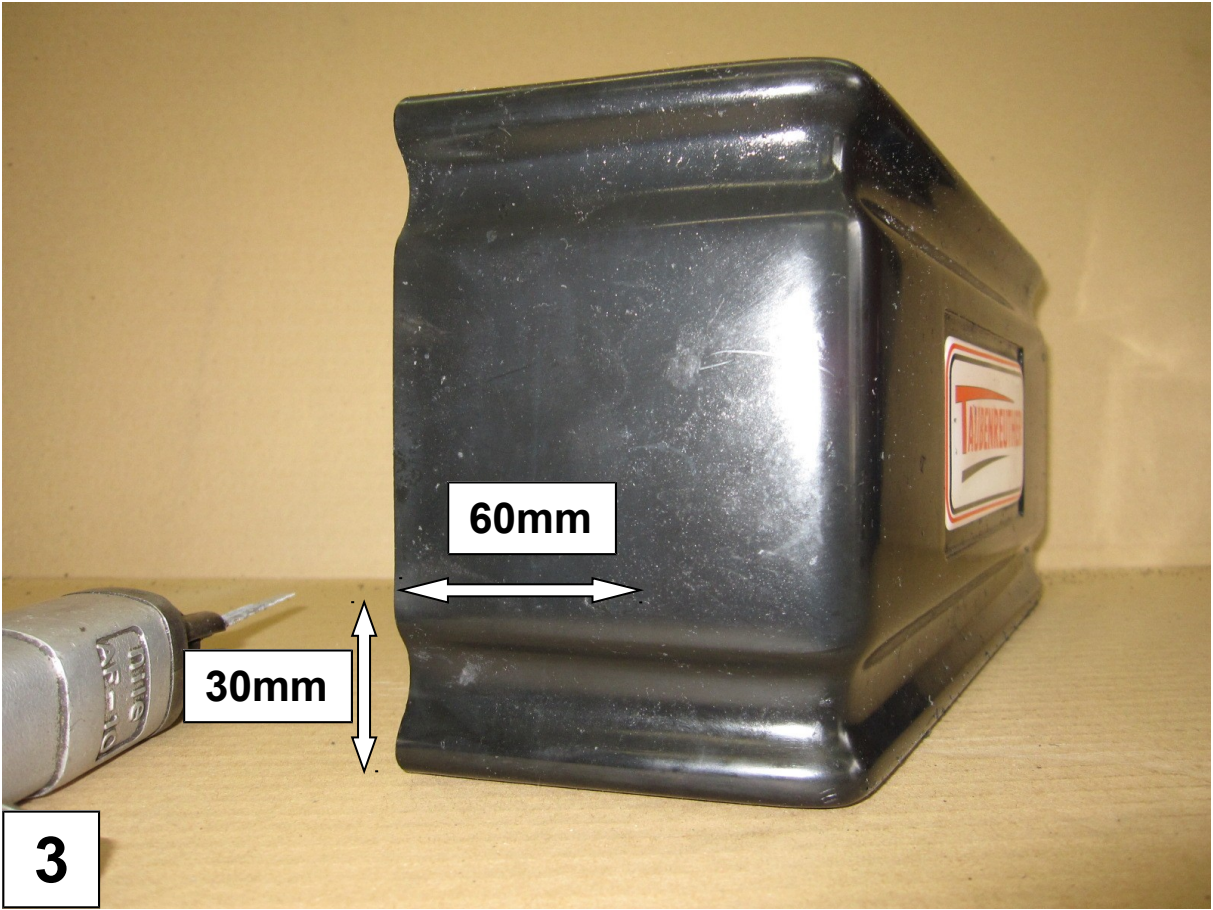

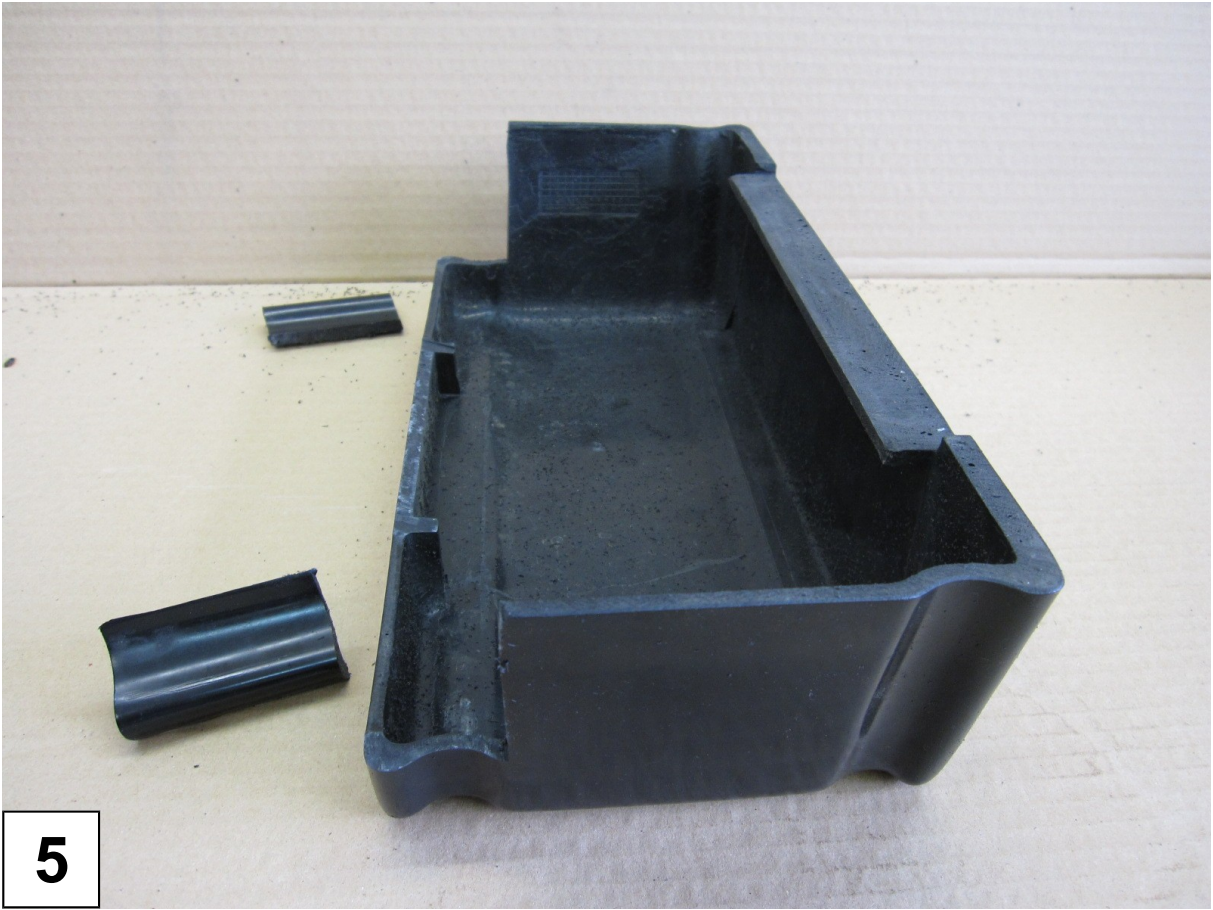

5



6