

Anbauanleitung Seilwindenanbausatz VW Amarok *Installation Instruction winch mounting kit VW Amarok*

Best.-Nr.: 16 - 5380

AL: 2008 – 06



**Hier sehen sie den fertig montierten Seilwindenanbausatz.
Bevor sie mit der Montage beginnen, lesen sie bitte diese Anleitung
und das Benutzerhandbuch der Seilwinde gut durch.**

Achtung:

Bei Fahrten im öffentlichen Straßenverkehr muß das Rollenseilfenster mit einer Kunststoffabdeckung abgedeckt werden.

Stückliste Seilwindenanbausatz VW Amarok

Partlist winch mounting kit VW Amarok

Best.nr.: 16 - 5380

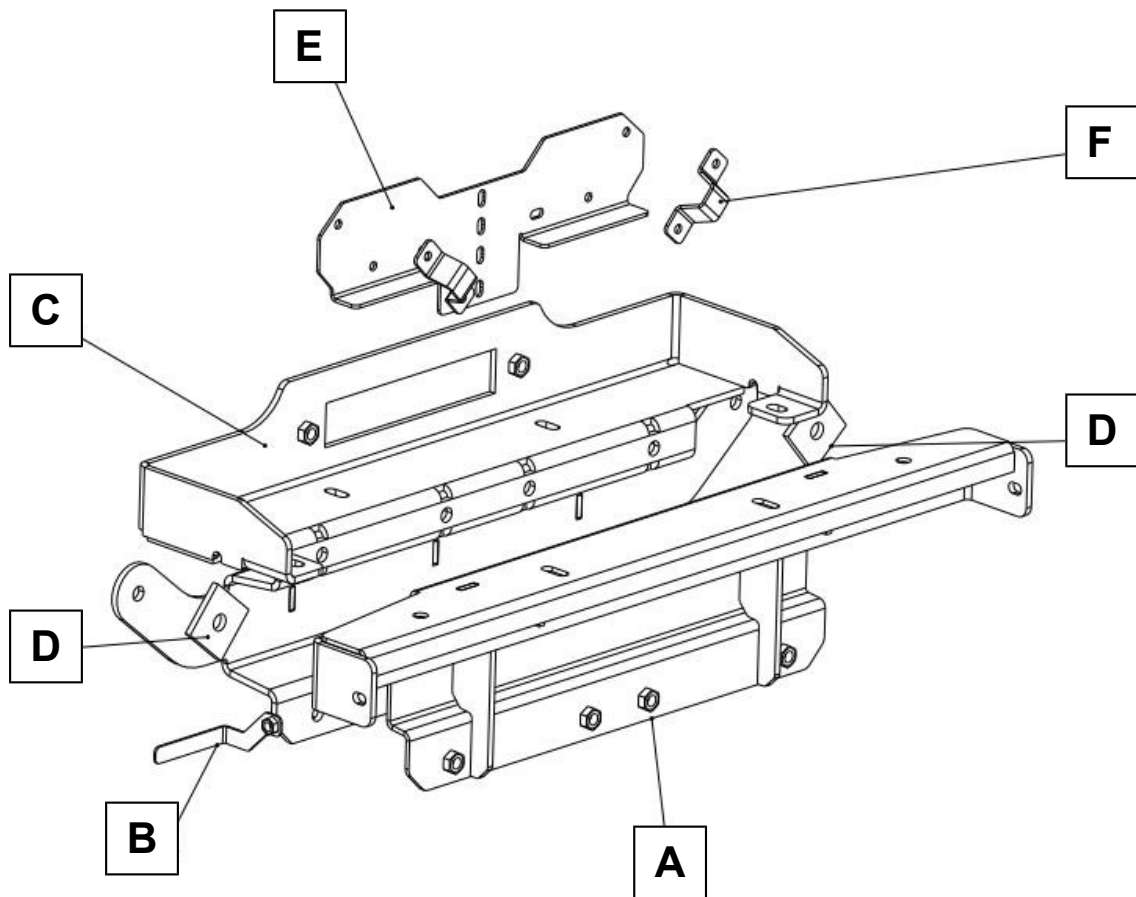

1 x Seilwindenträger hinten (A)	2 x Schraube M 12 x 40
1 x Halter mit Mutter (B)	4 x U-Scheibe M 12 x 40 x 3
1 x Seilwindenträger vorne (C)	2 x Federring M 12
2 x Distanzplatte (D)	2 x Mutter M 12
1 x Schaltkastenhalter (E)	10 x Schraube M 10 x 30
2 x Schelle (F)	2 x Schraube M 10 x 25
1 x Anbauanleitung AL 2008	14 x U-Scheibe M 10 x 30 x 2
1 x Gutachten	12 x Federring M 10
	2 x Schraube M 8 x 30
	2 x U – Scheibe M 8
	4 x U-Scheibe M8 x 25 x 2
	2 x Federring M 8
	2 x Schraube M 6 x 20
	4 x Schraube M 6 x 30
	8 x U-Scheibe M 6
	4 x U – Scheibe M6 x 15 x 1,5
	6 x Federring M 6
	6 x Mutter M 6

Achtung: Wenn sie eine **ZEON** Winde verbauen möchten, empfehlen wir dringend die Verwendung der Steckdosenverlängerung 1- 90394 !

Attention: If you want to fit a **ZEON** winch, we recommend to use the socket extension kit 1-90394 !

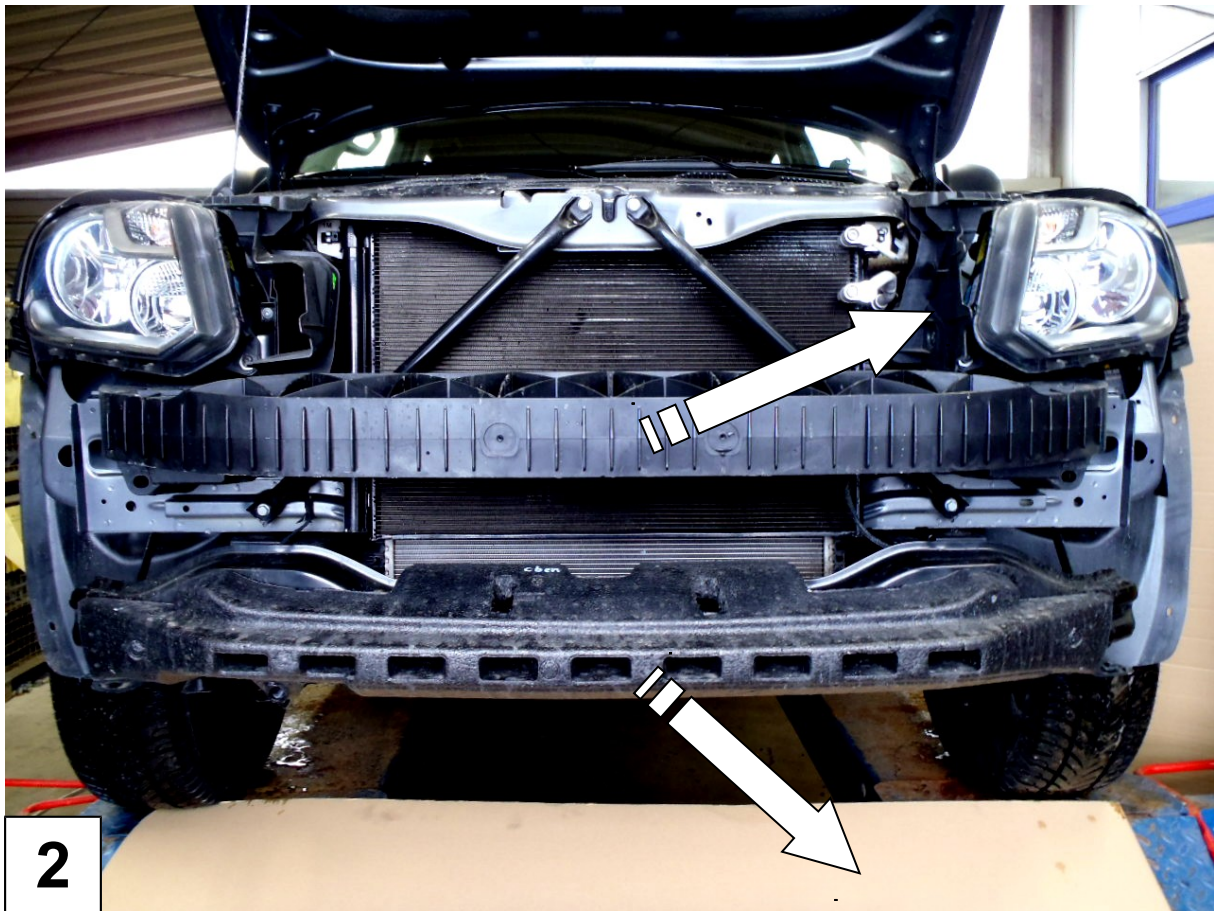

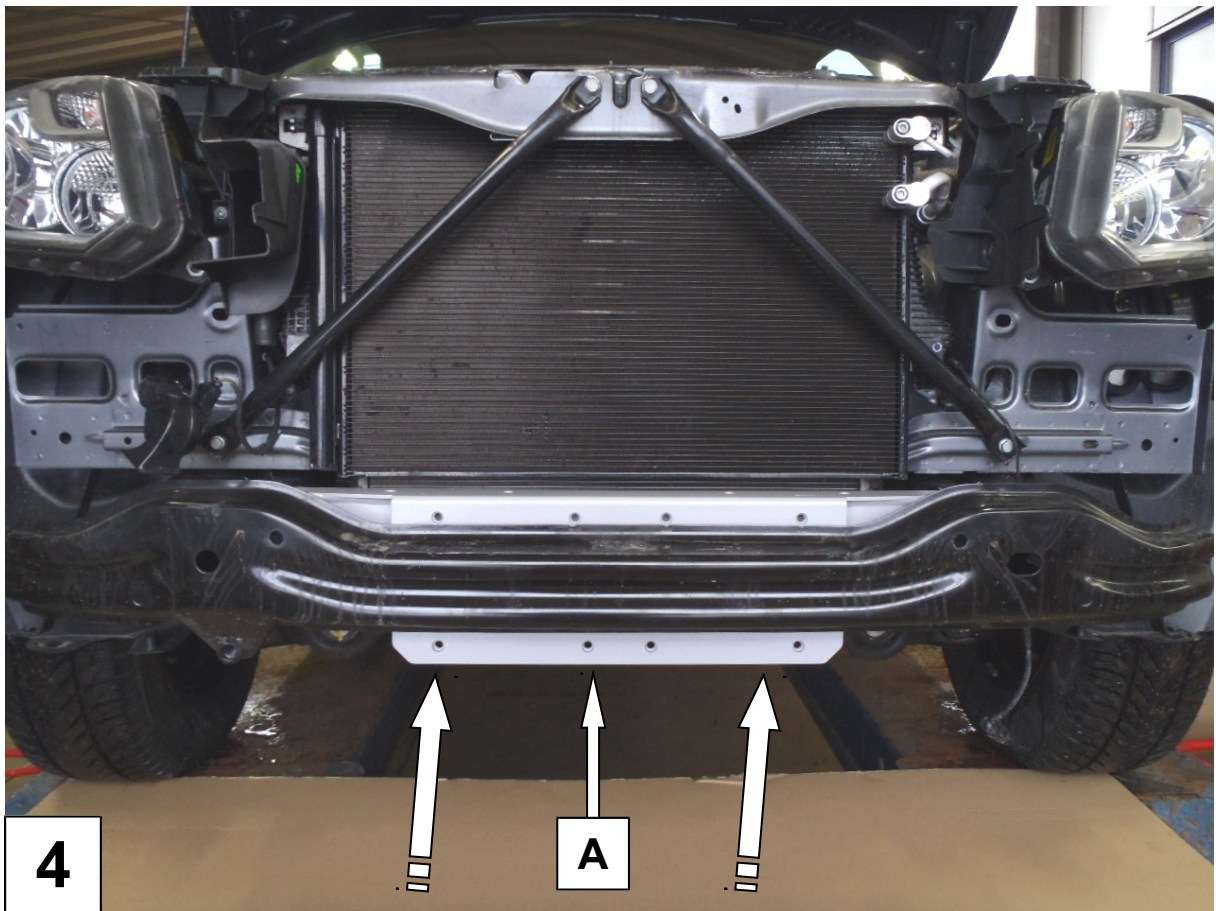

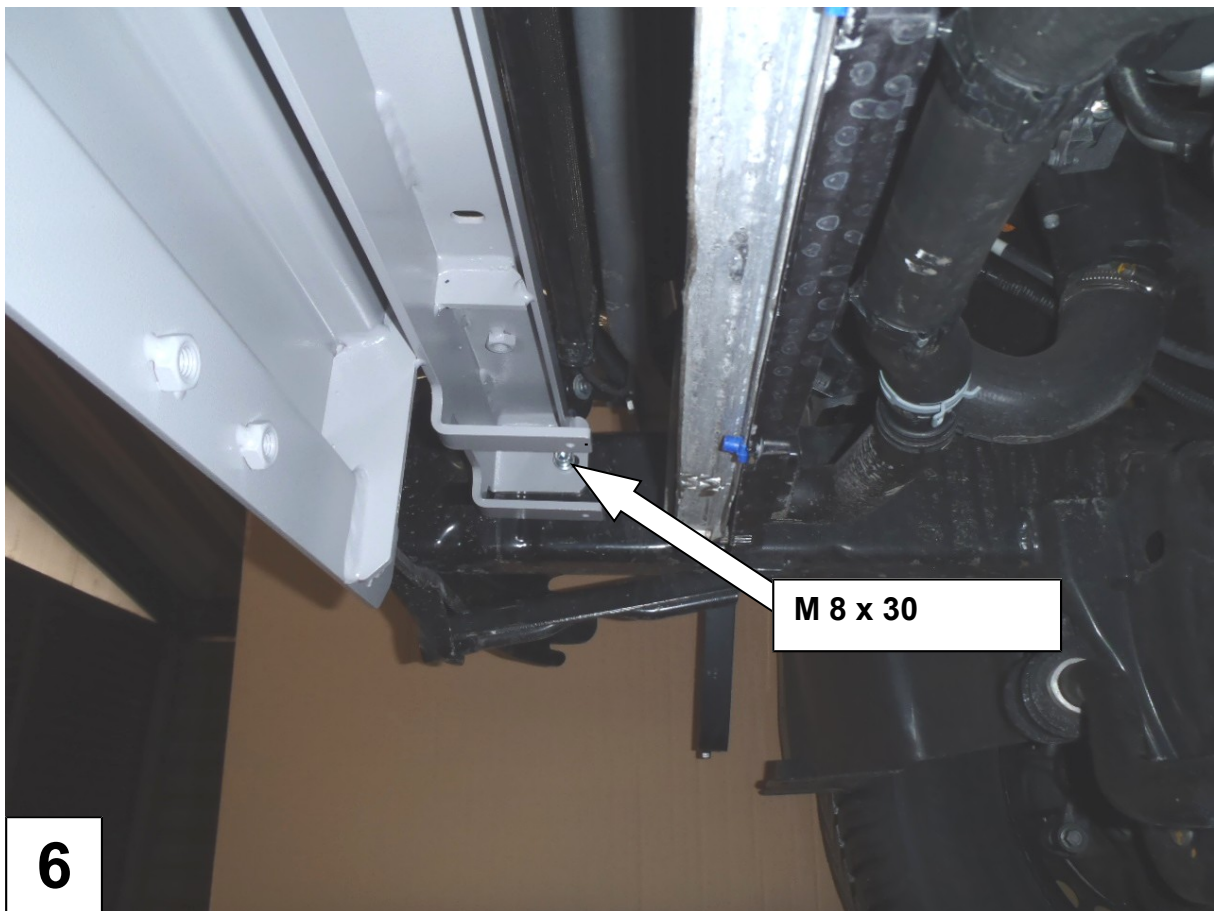
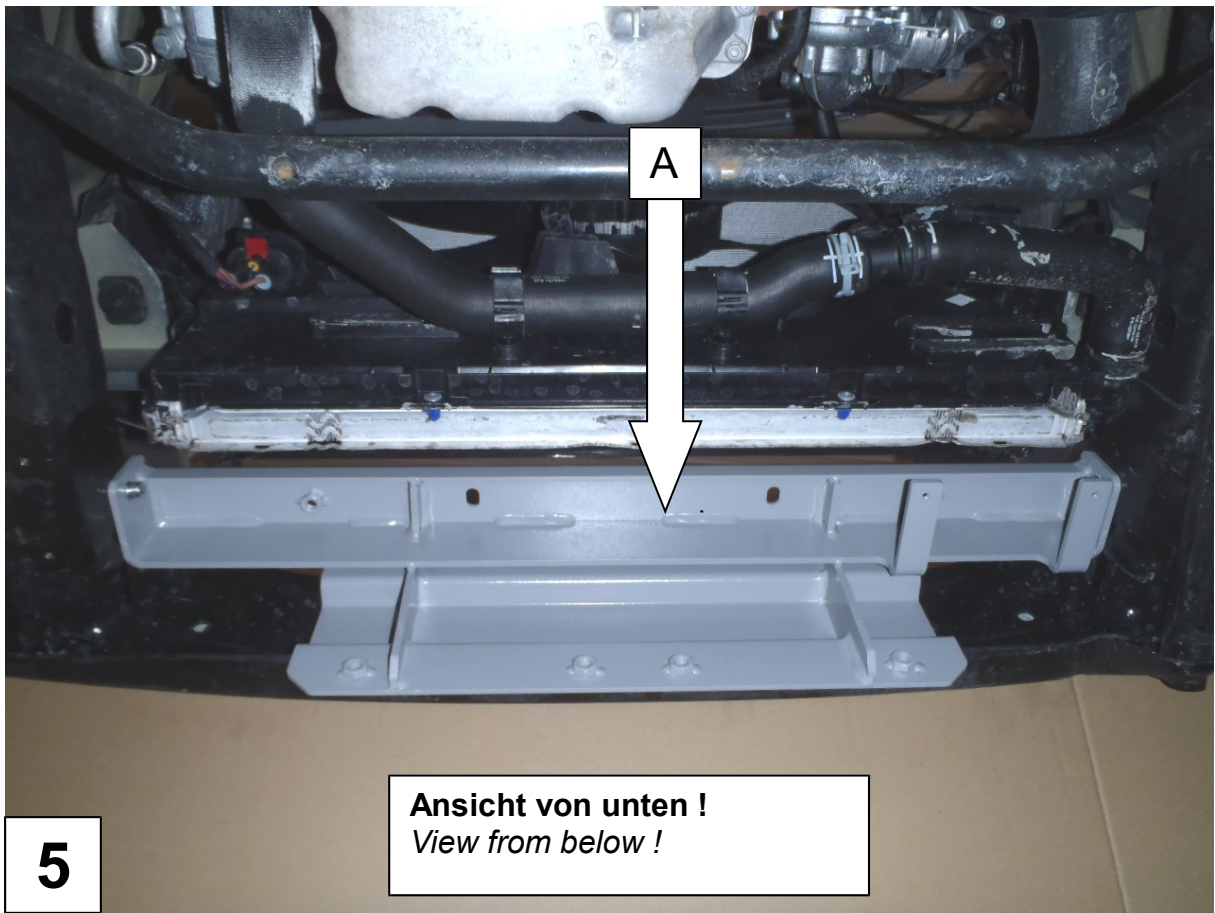

Toleranzen sollten mit den U-Scheiben 8 x 25 x 2 ausgeglichen werden!
Tolerances should get balanced with the shims 8 x 25 x 2!

M 8 x 30

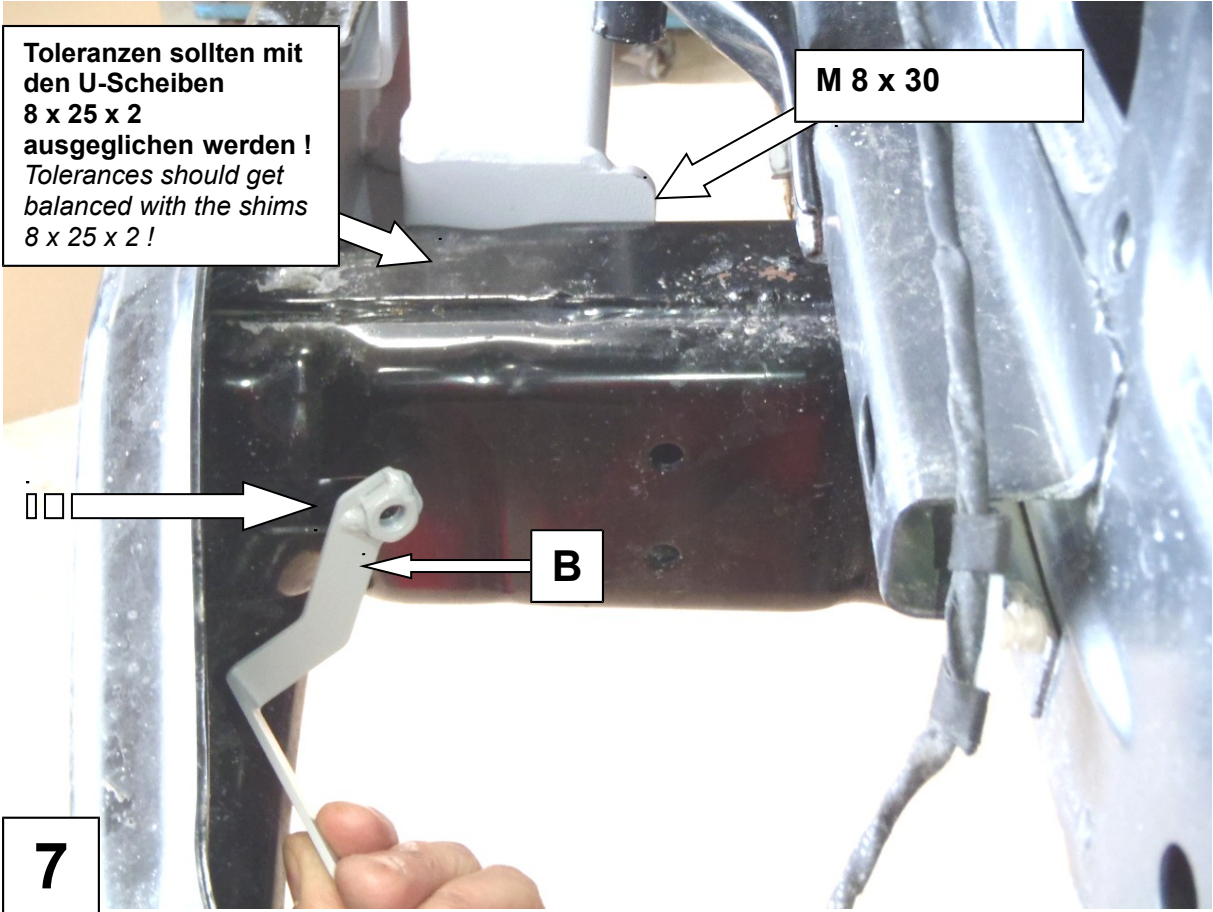

7

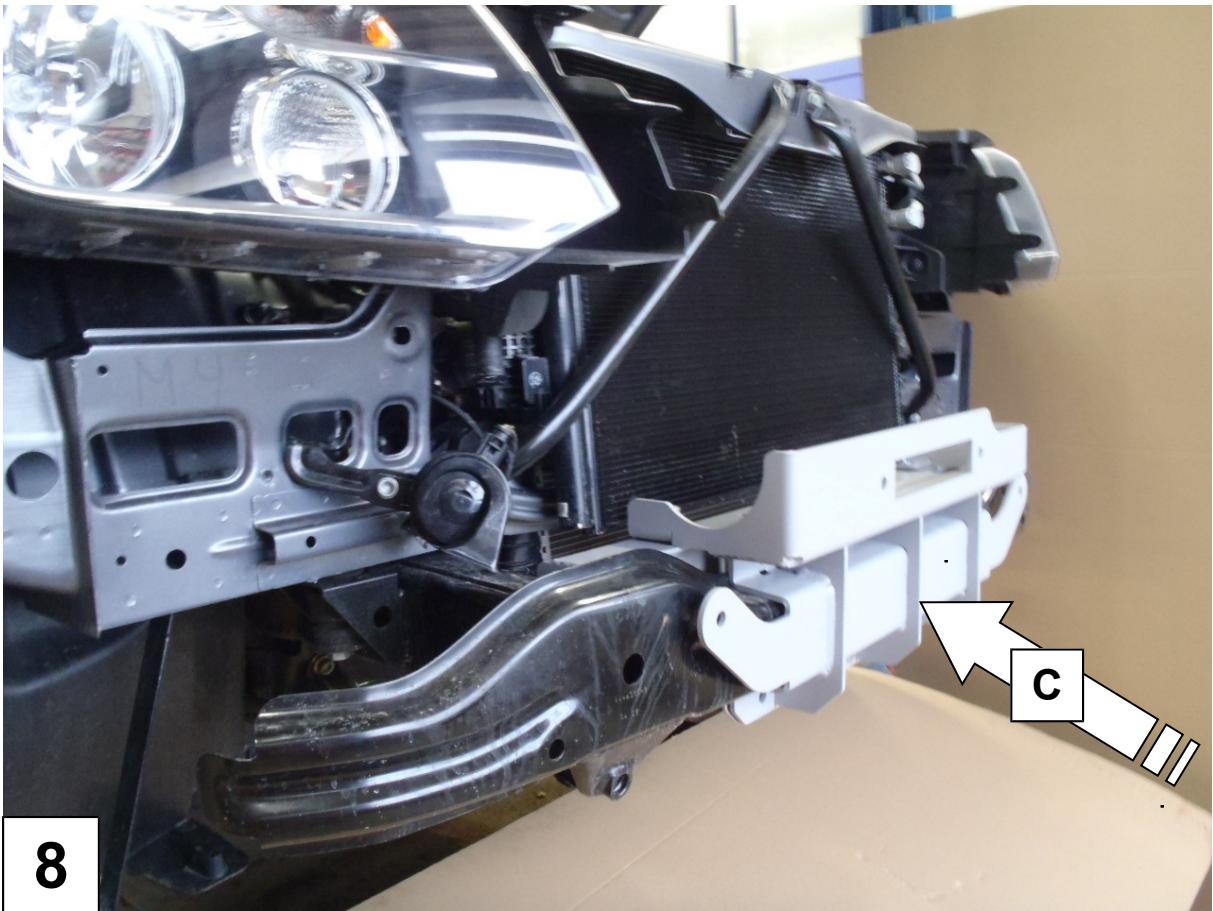

C

8

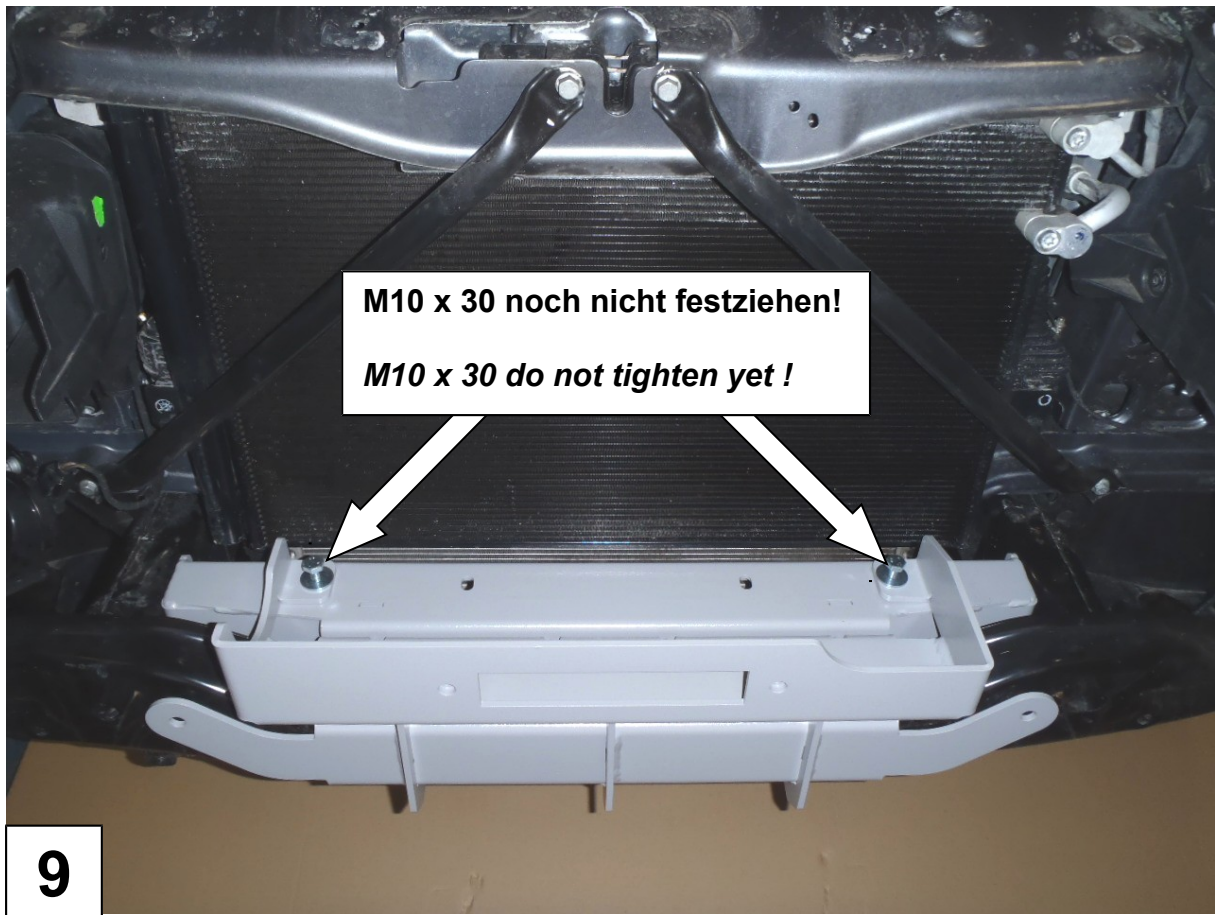

9



10

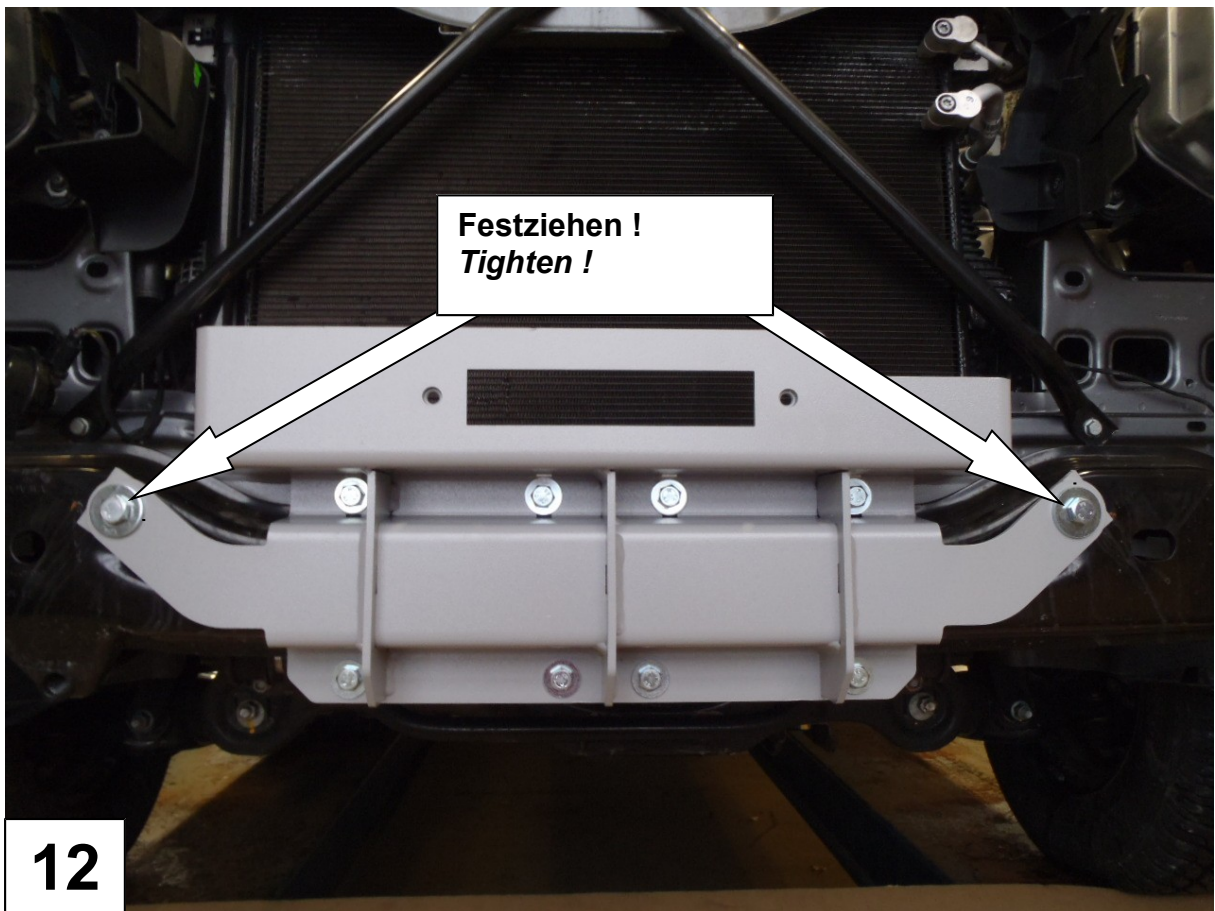
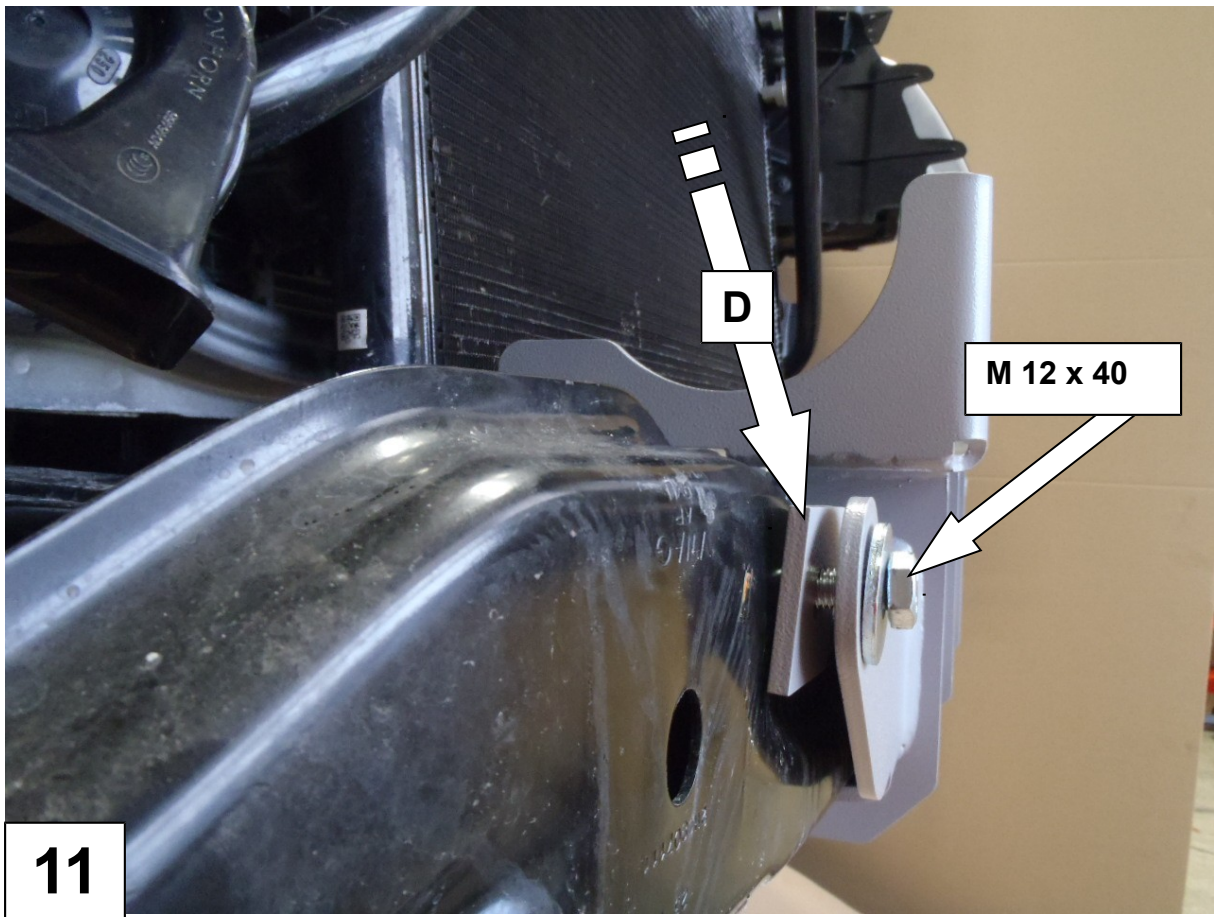

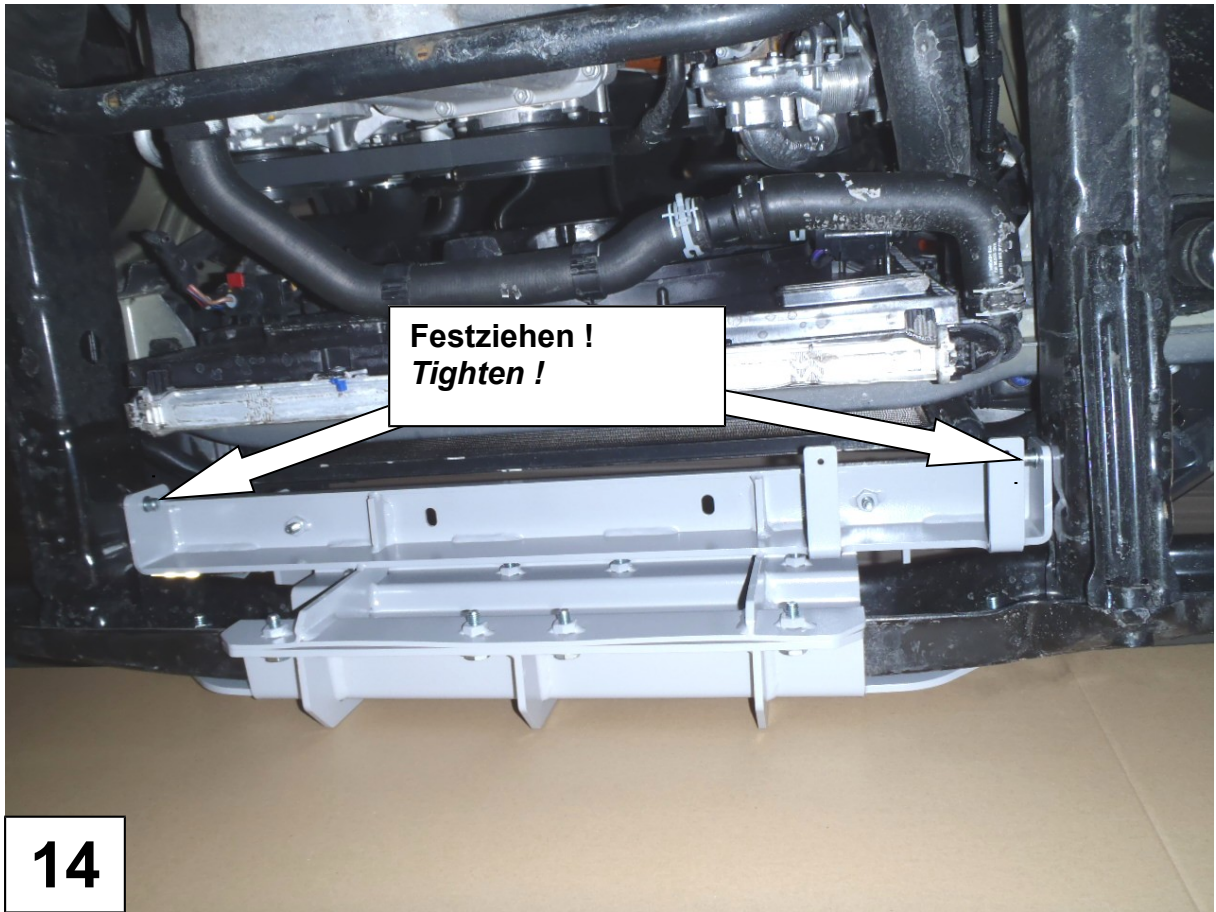
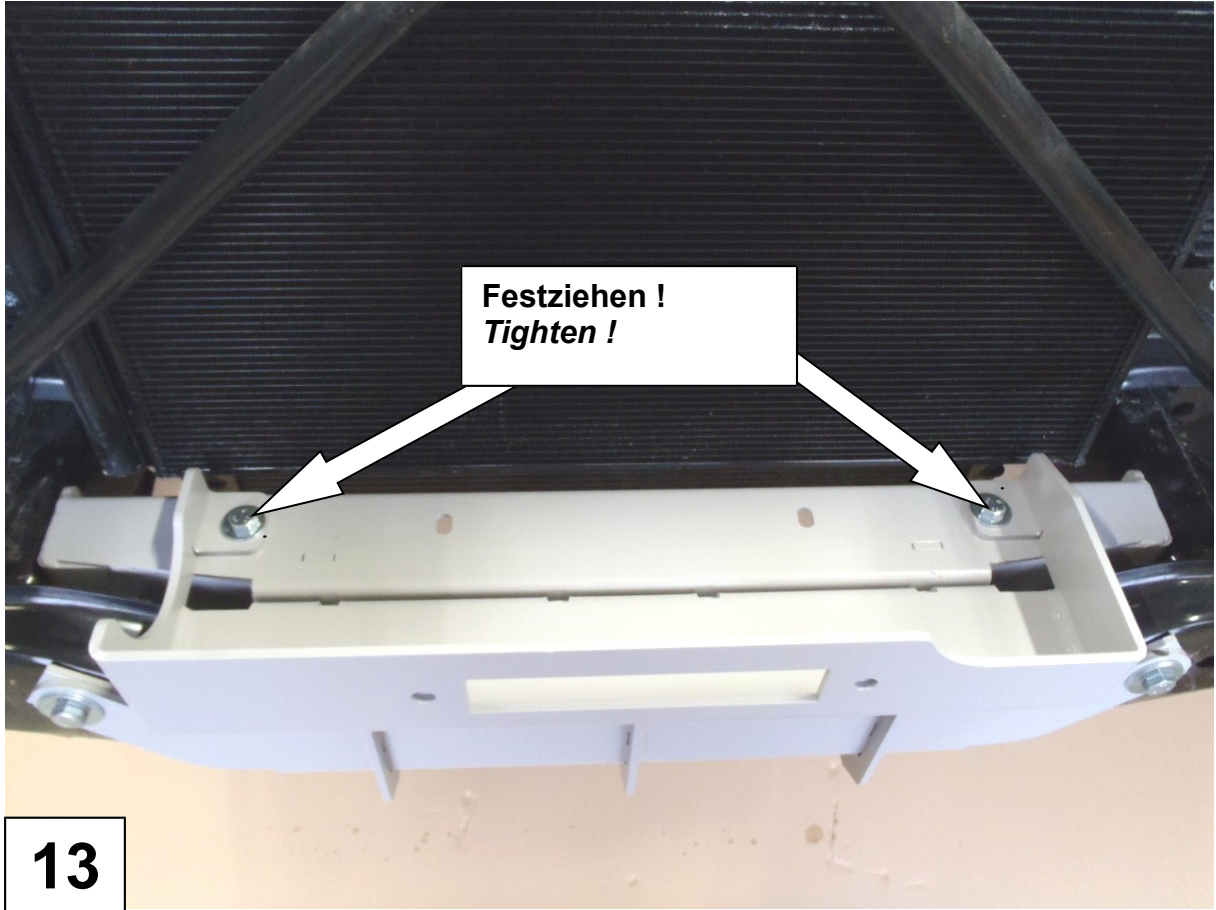

Bei Verwendung einer ZEON-Winde,
weiter mit Bild 24 !
*If you want to fit a ZEON-winch go on with
picture 24 !*

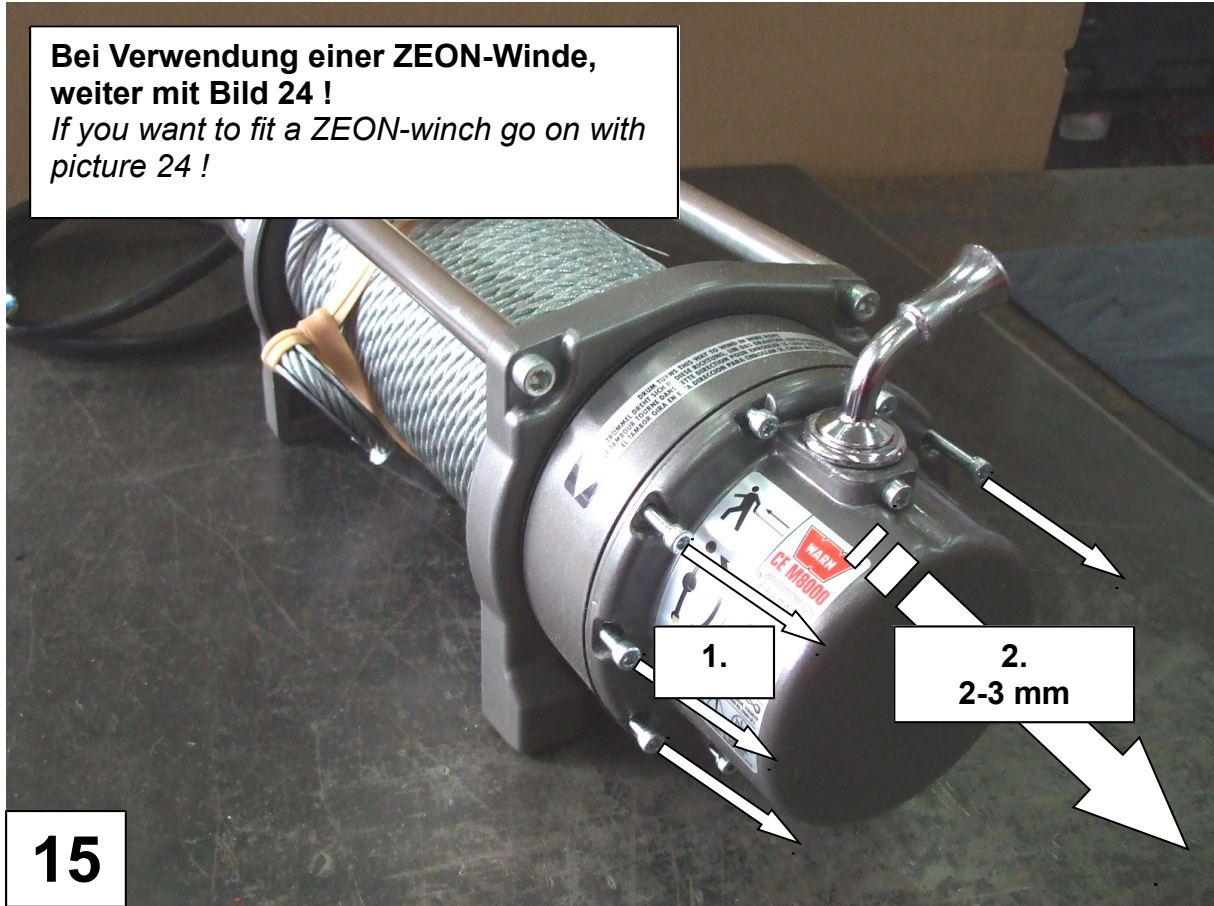

15

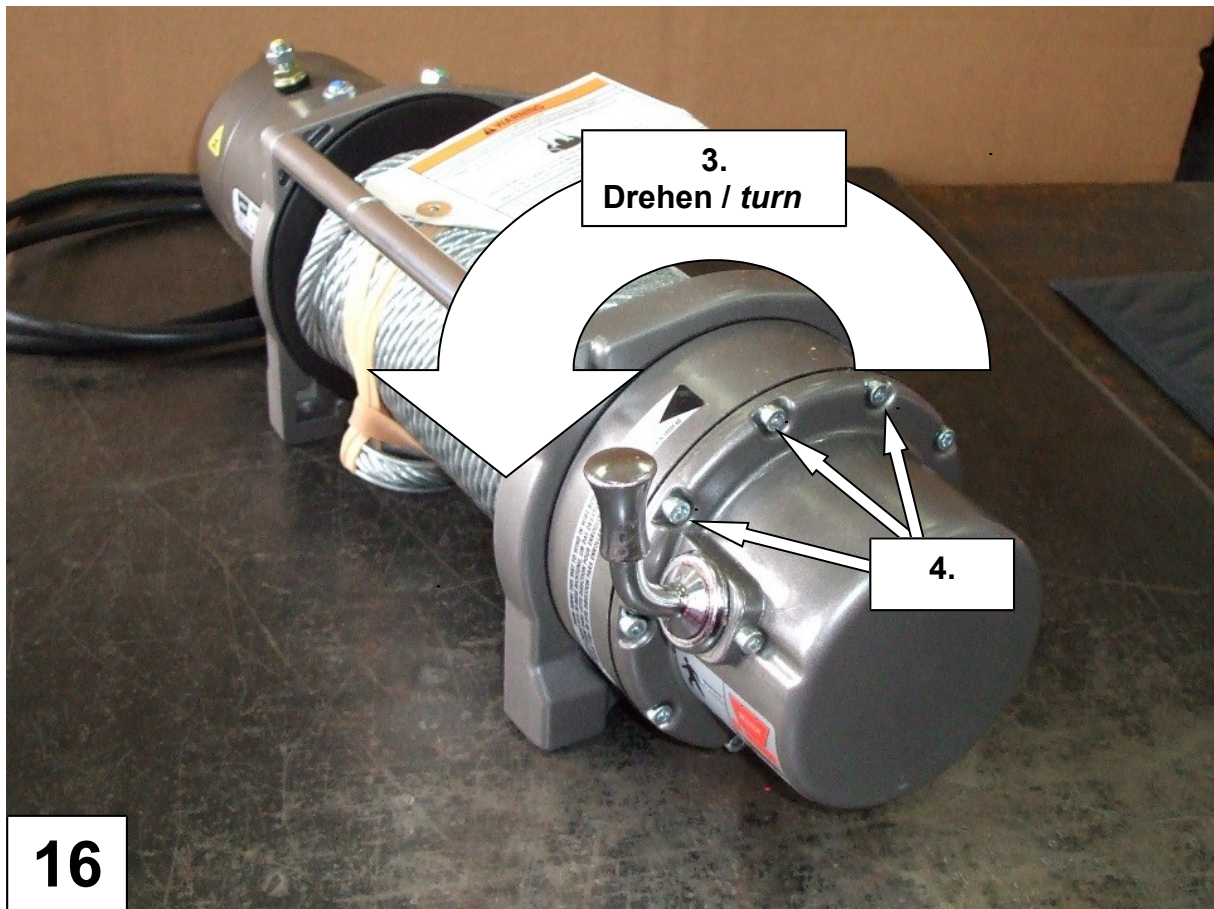

16

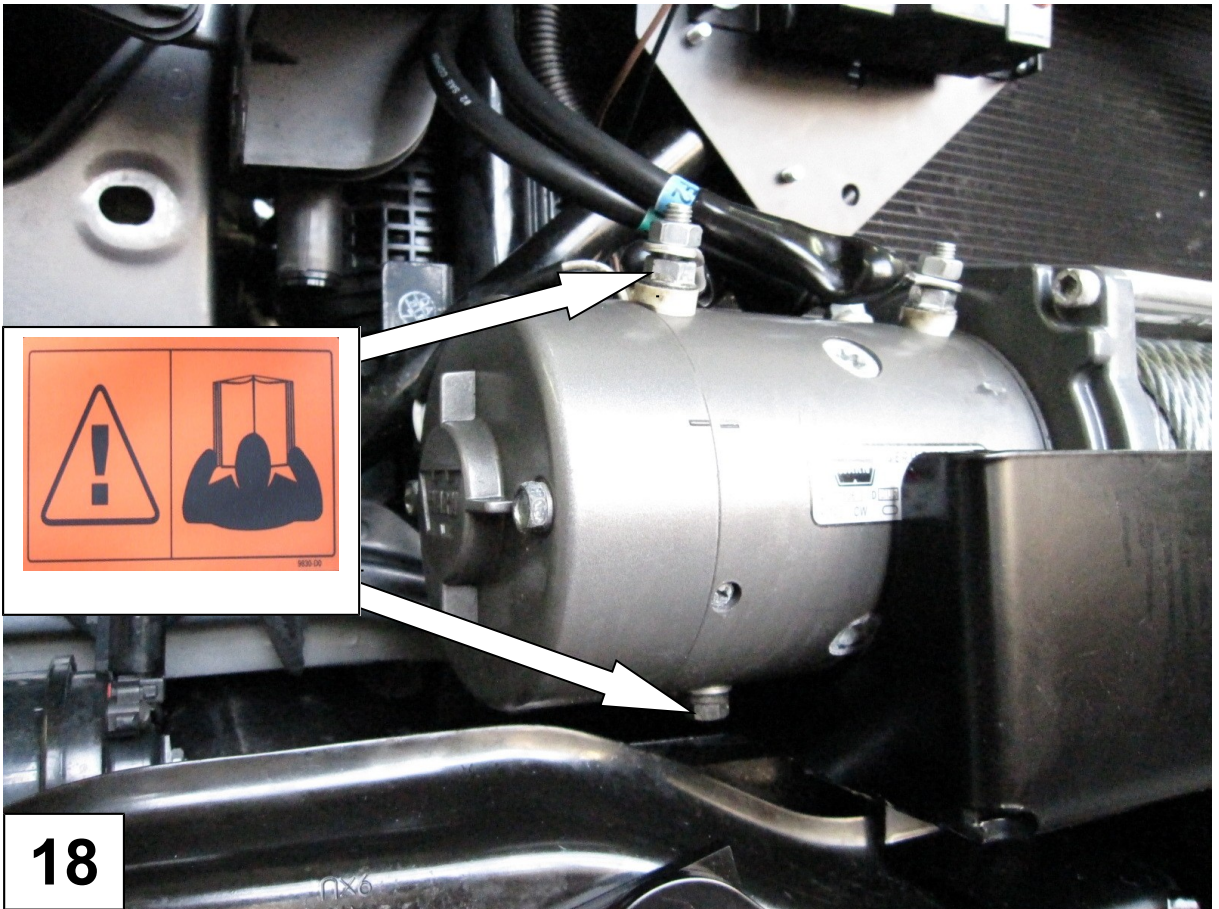
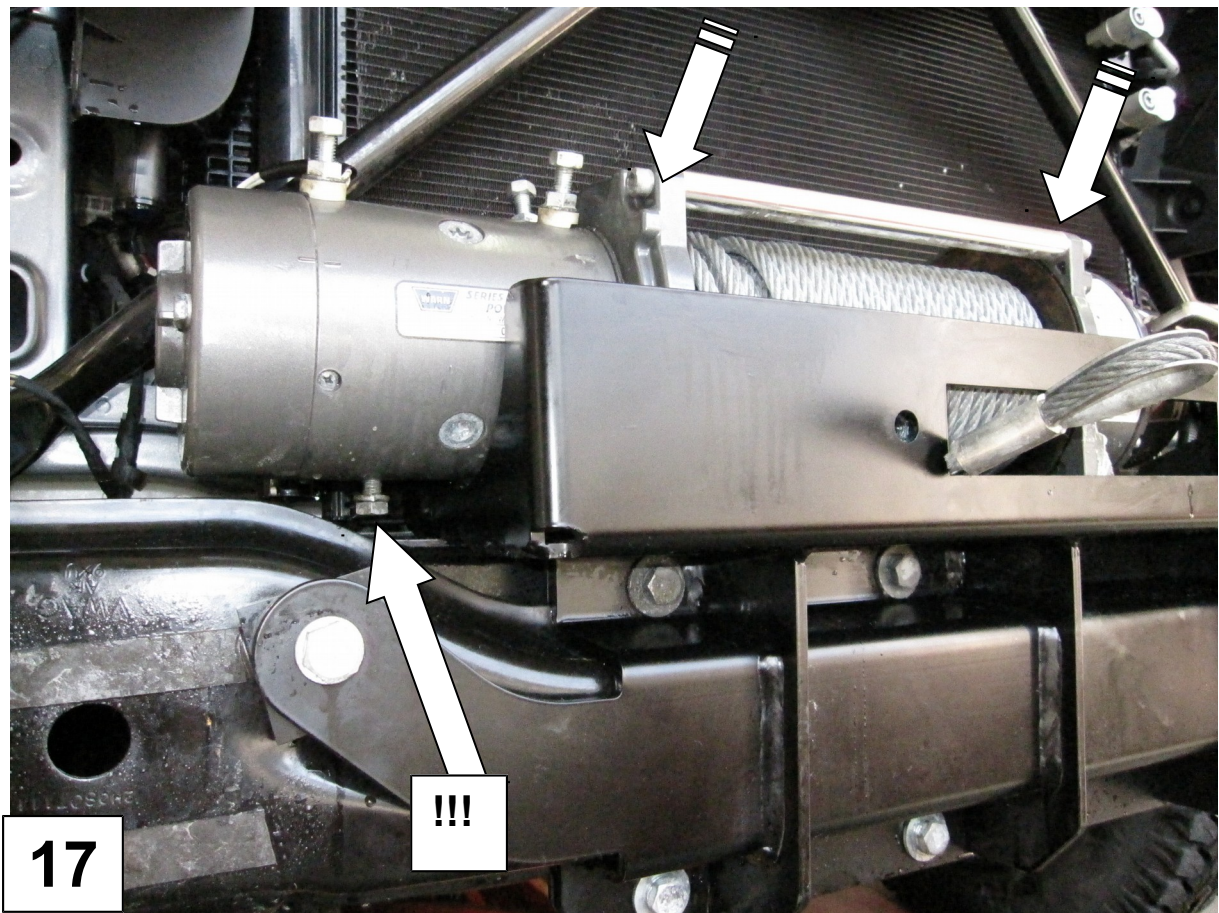

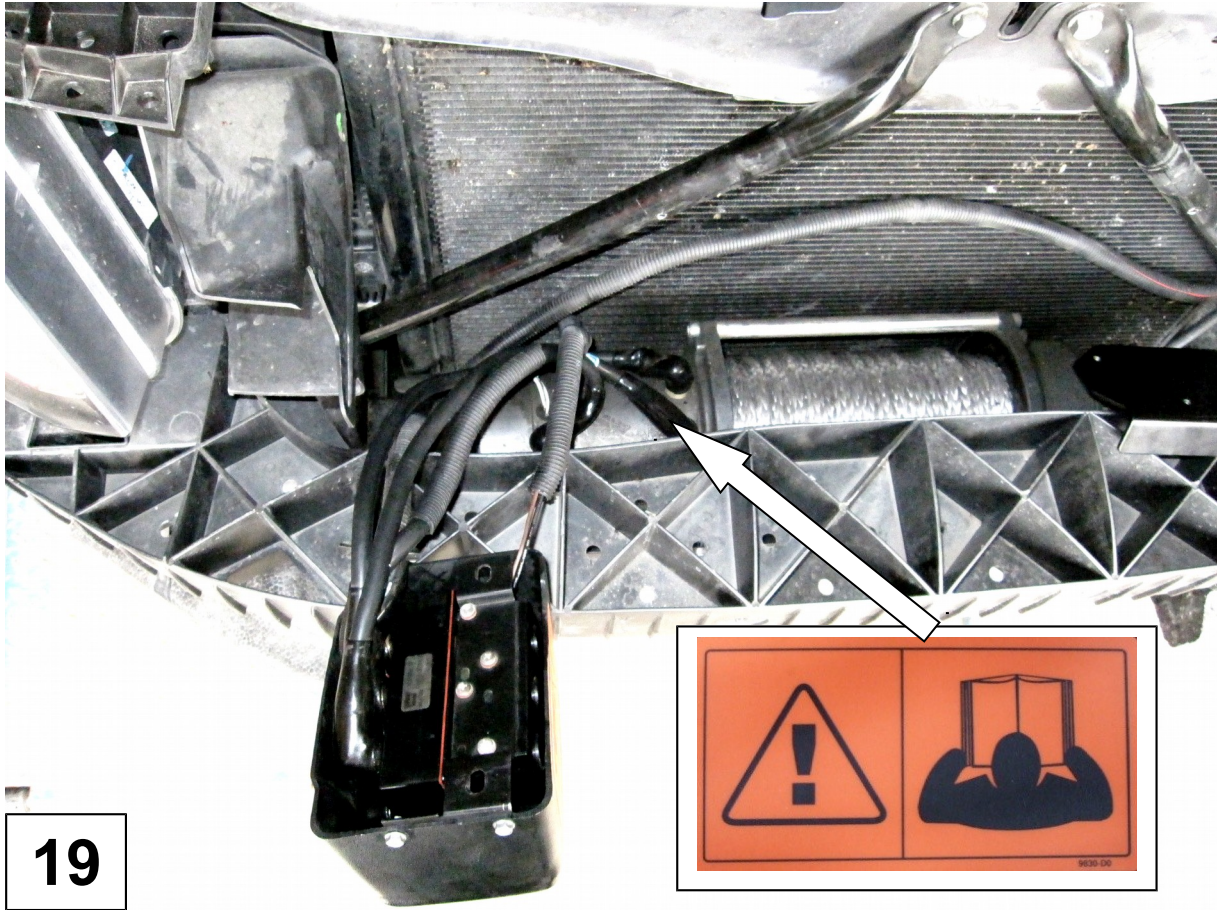

19

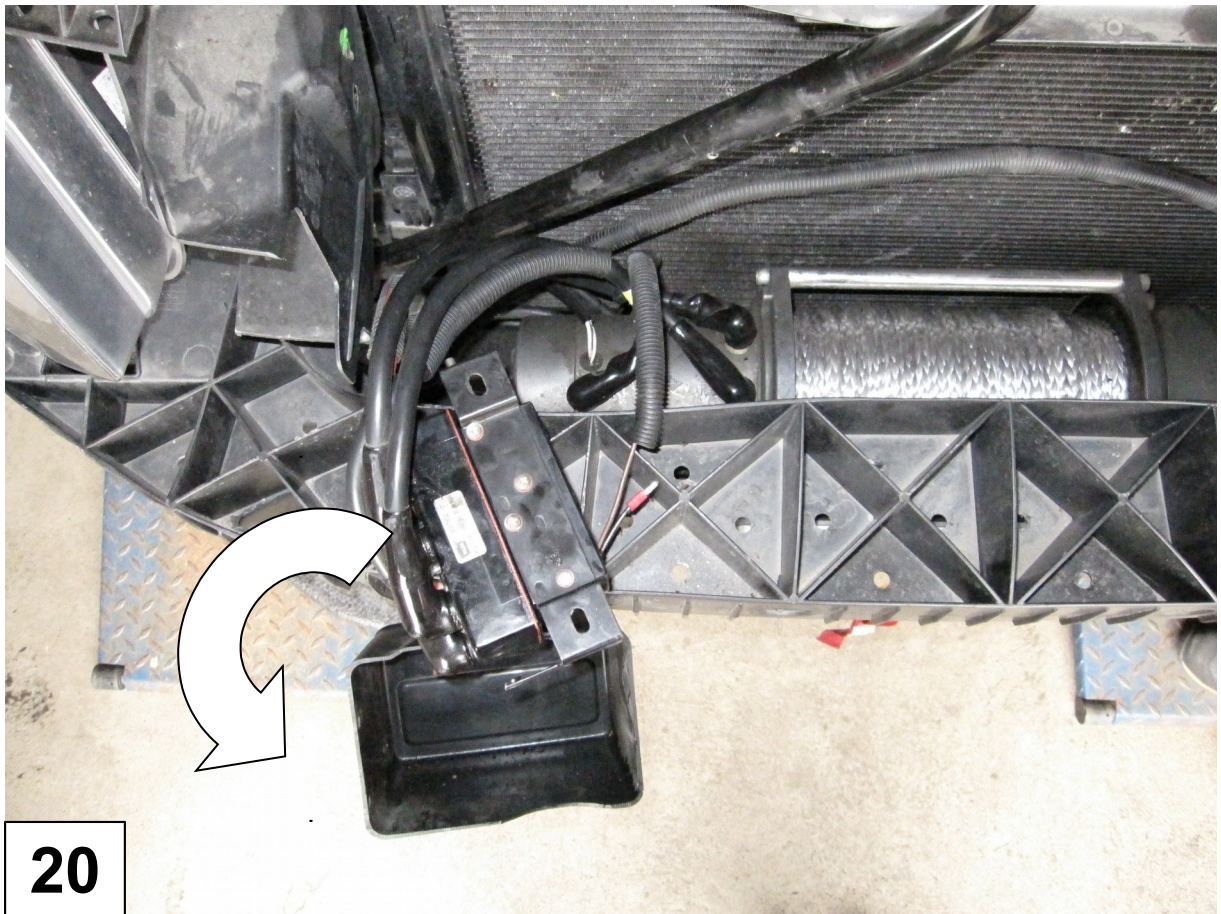

20

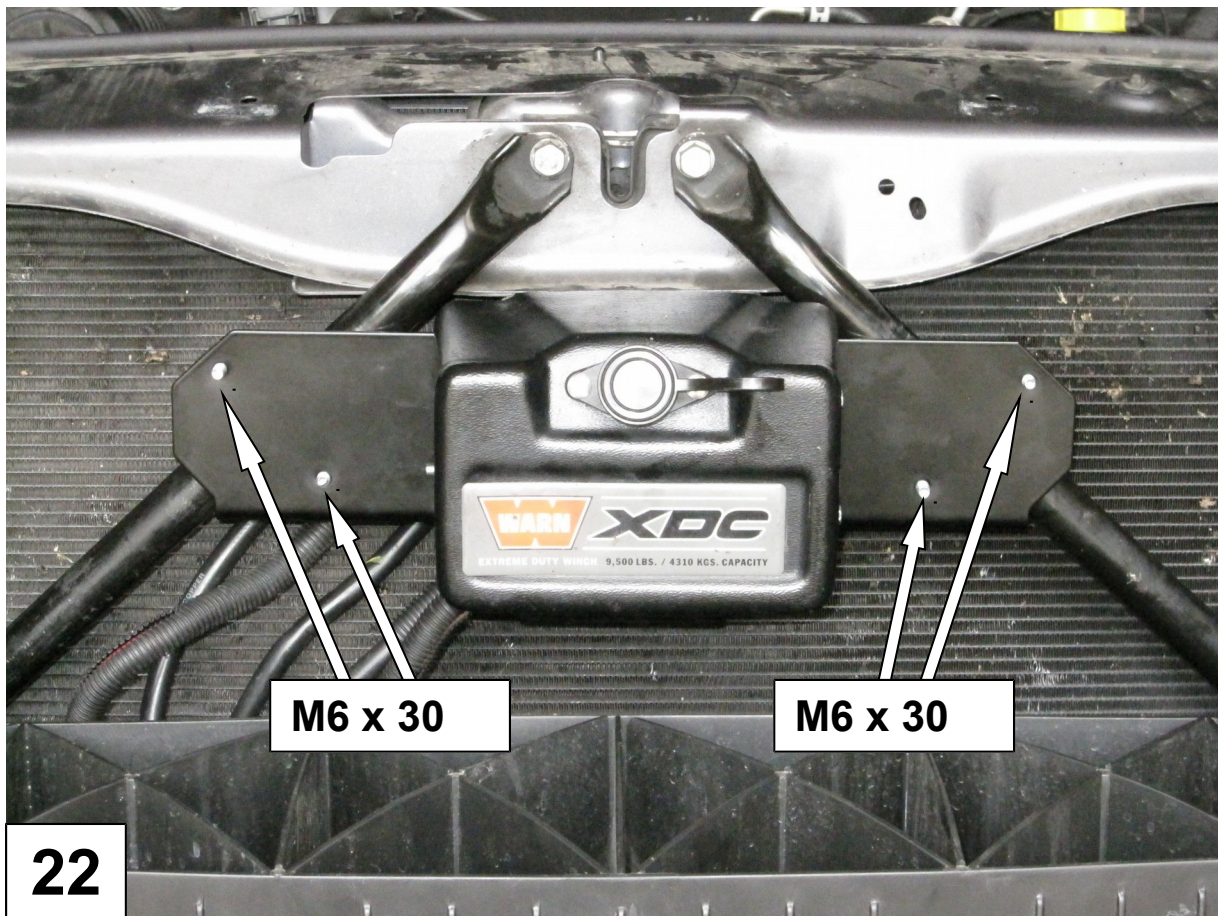
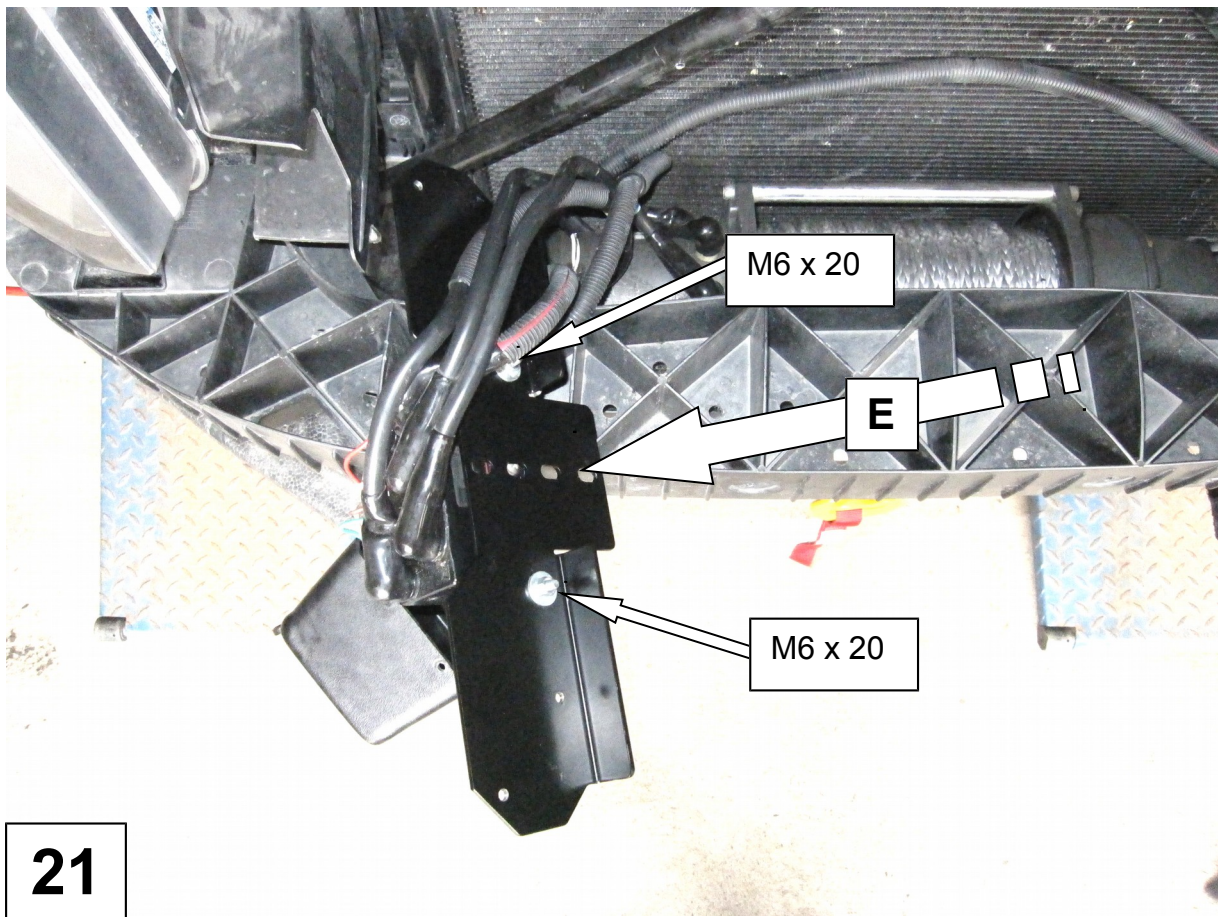

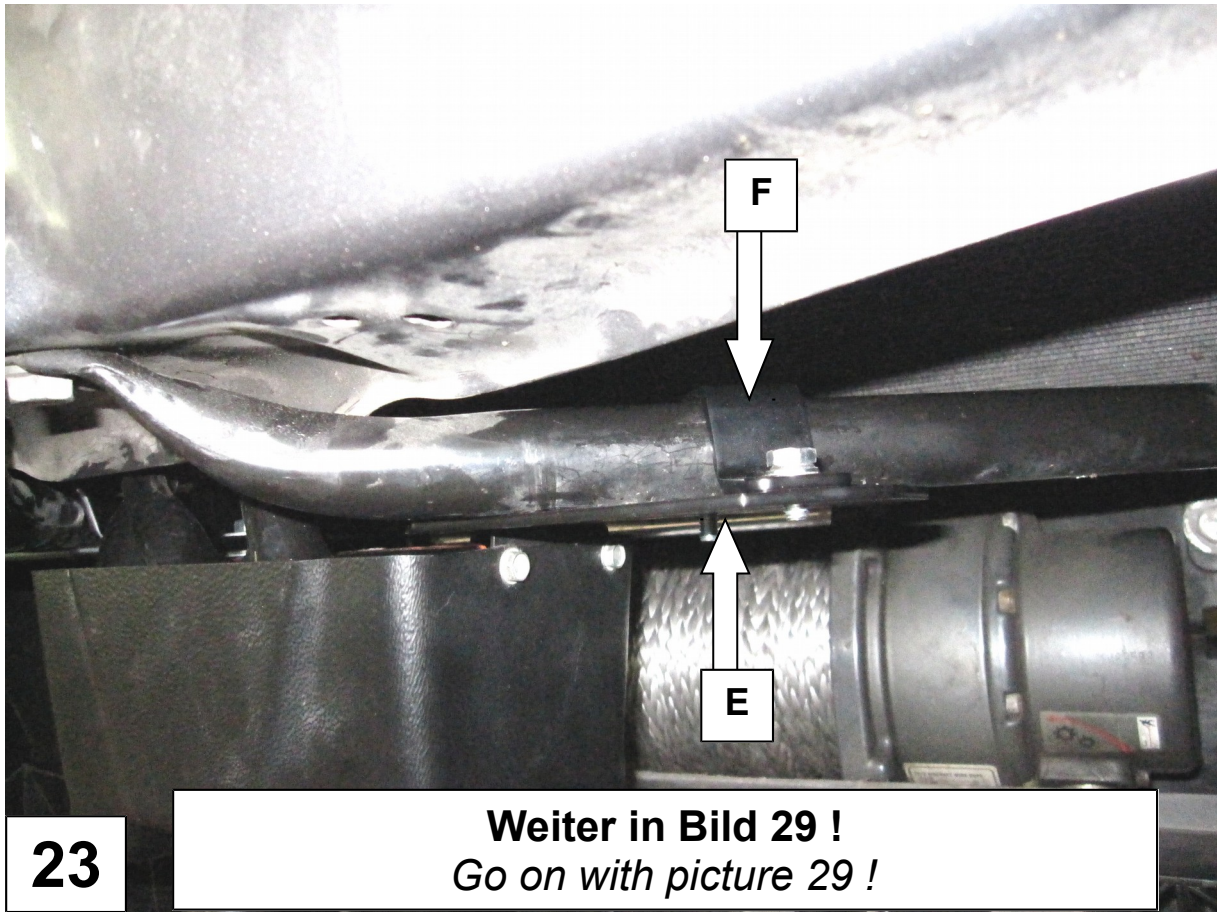

23

Weiter in Bild 29 !
Go on with picture 29 !

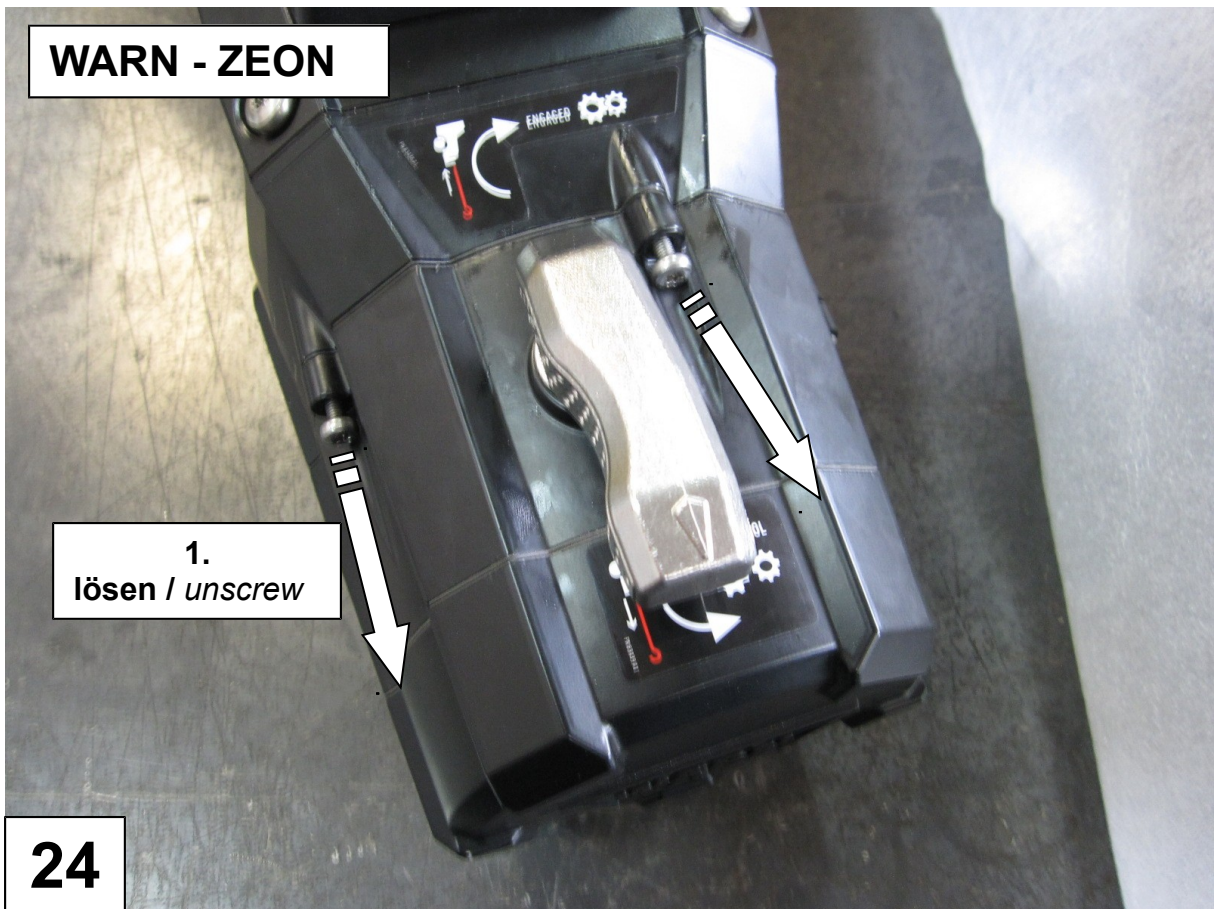

WARN - ZEON

1.
lösen / unscrew

24

WARN - ZEON

2.
Drehen / turn

25

WARN - ZEON

3.
festziehen
tighten

26

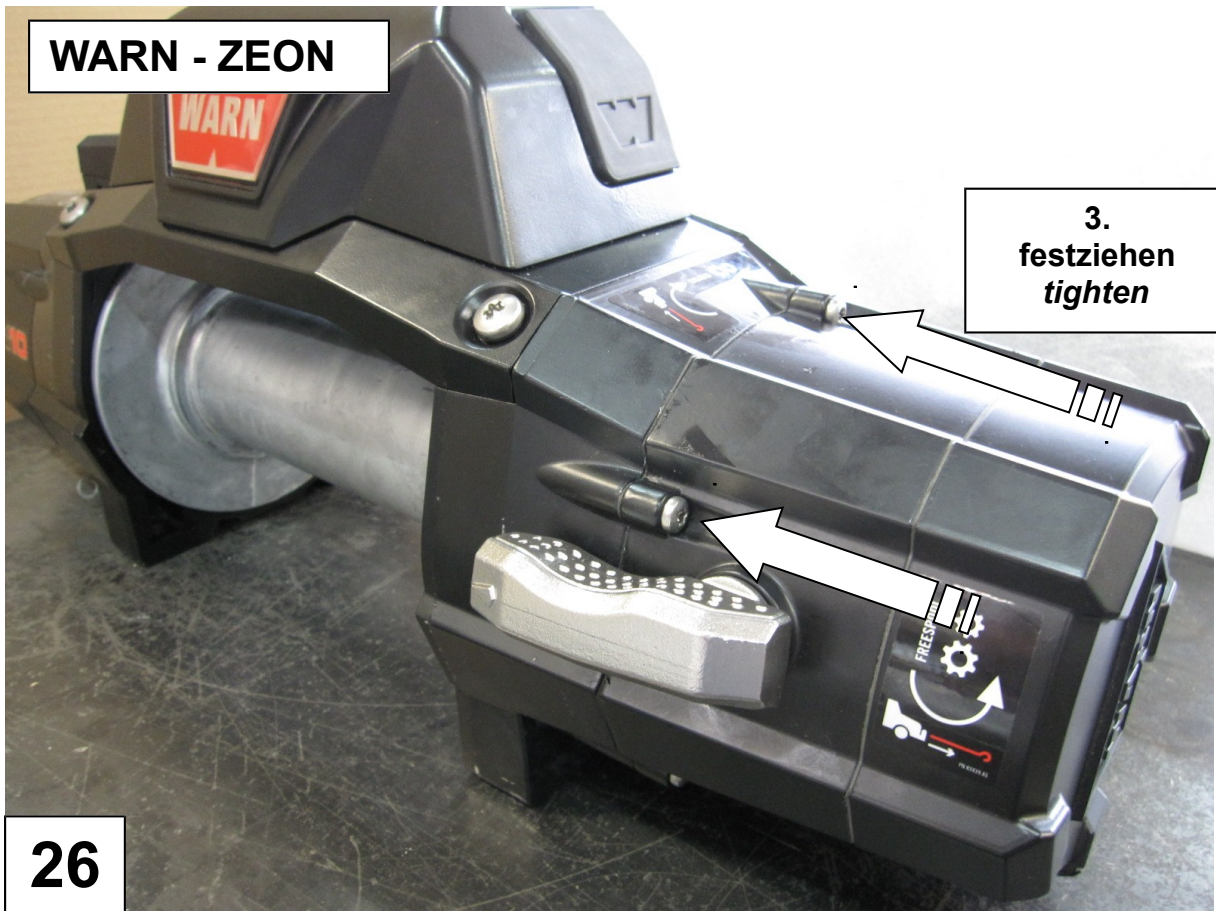
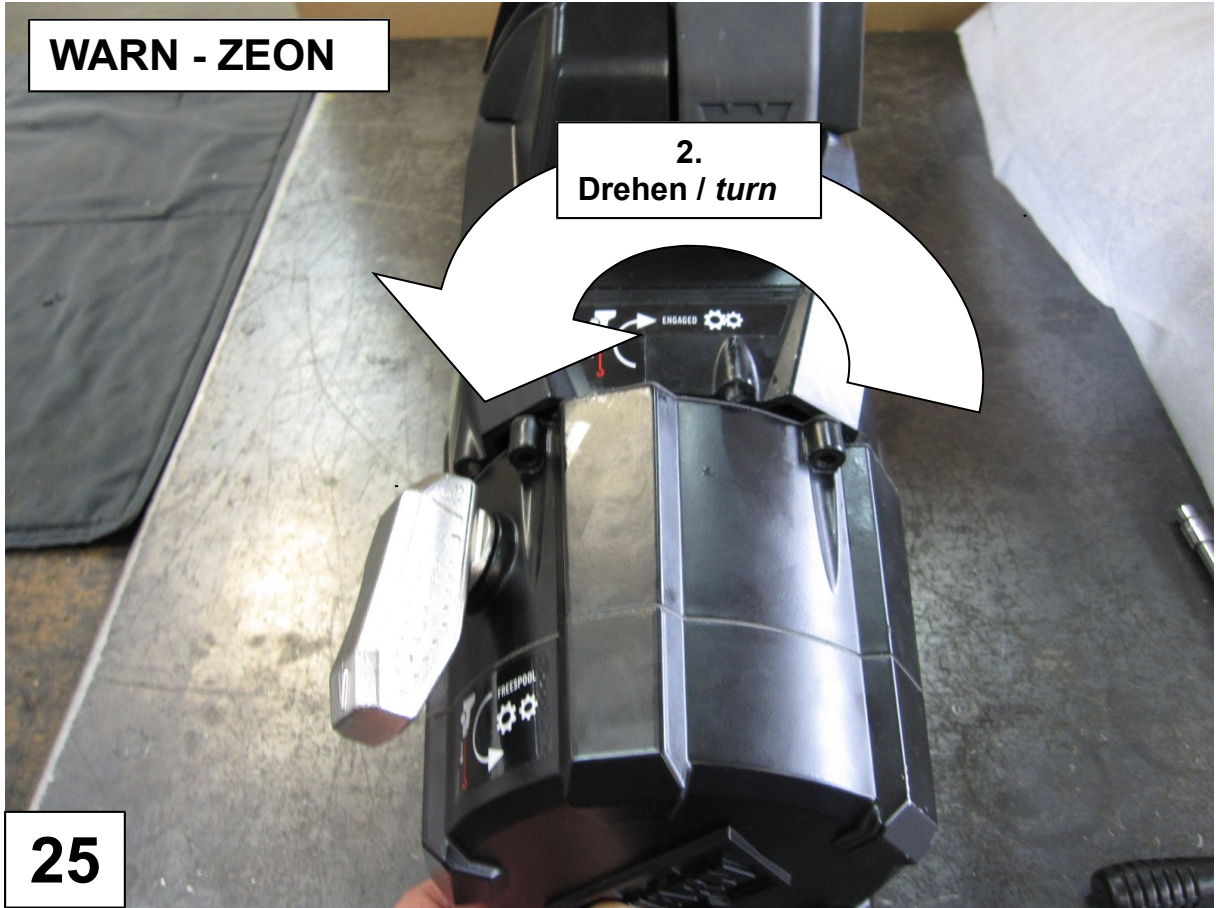

WARN - ZEON

**Wir empfehlen den
Einbau der Steckdosen-
verlängerung 1-90394 !**

*We recommend the
installation of socket
extension kit 1-90394 !*

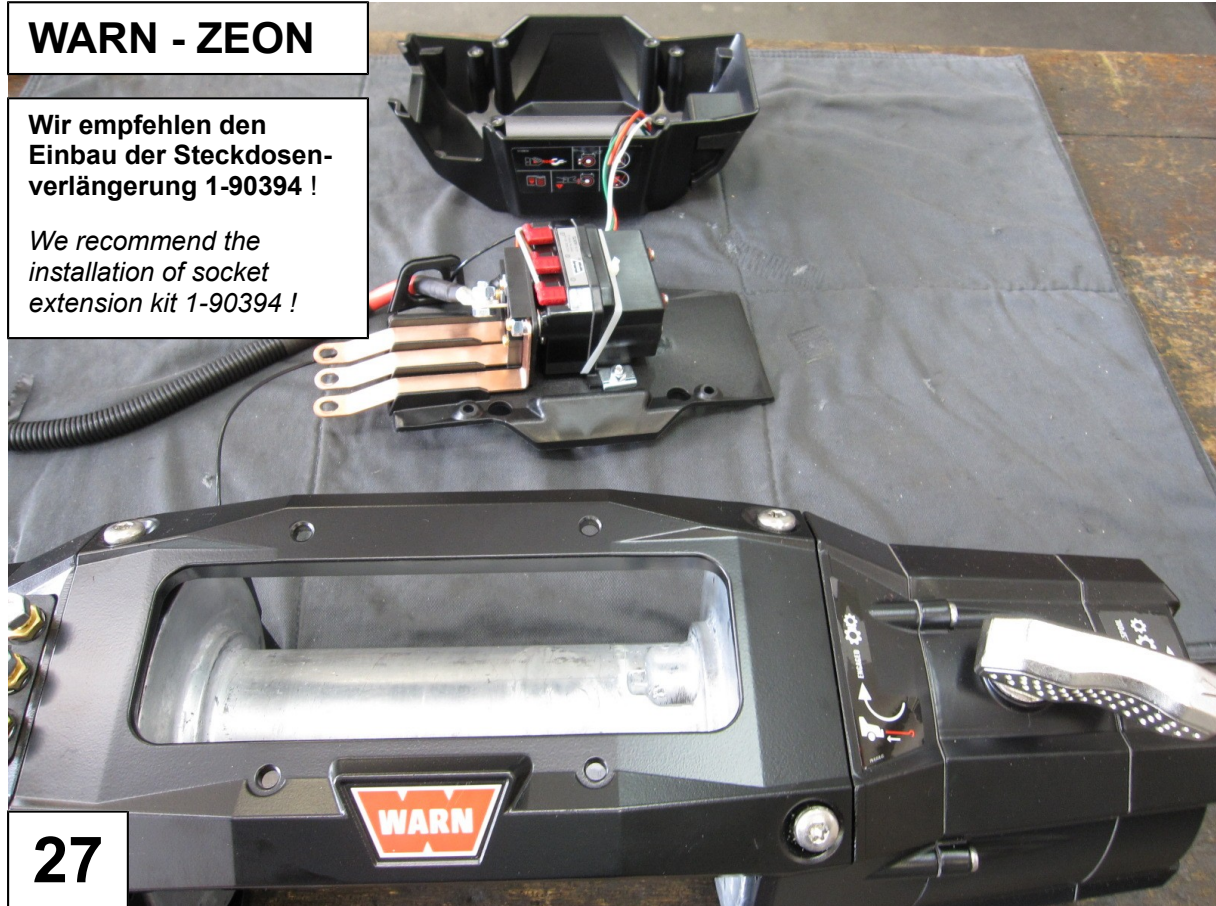

27

WARN - ZEON

Befestigen sie die Steckdose des Verlängerungskits an einem platz ihrer Wahl.

Fit the socket of the extension kit to a position of your choice !



28

WARN - ZEON

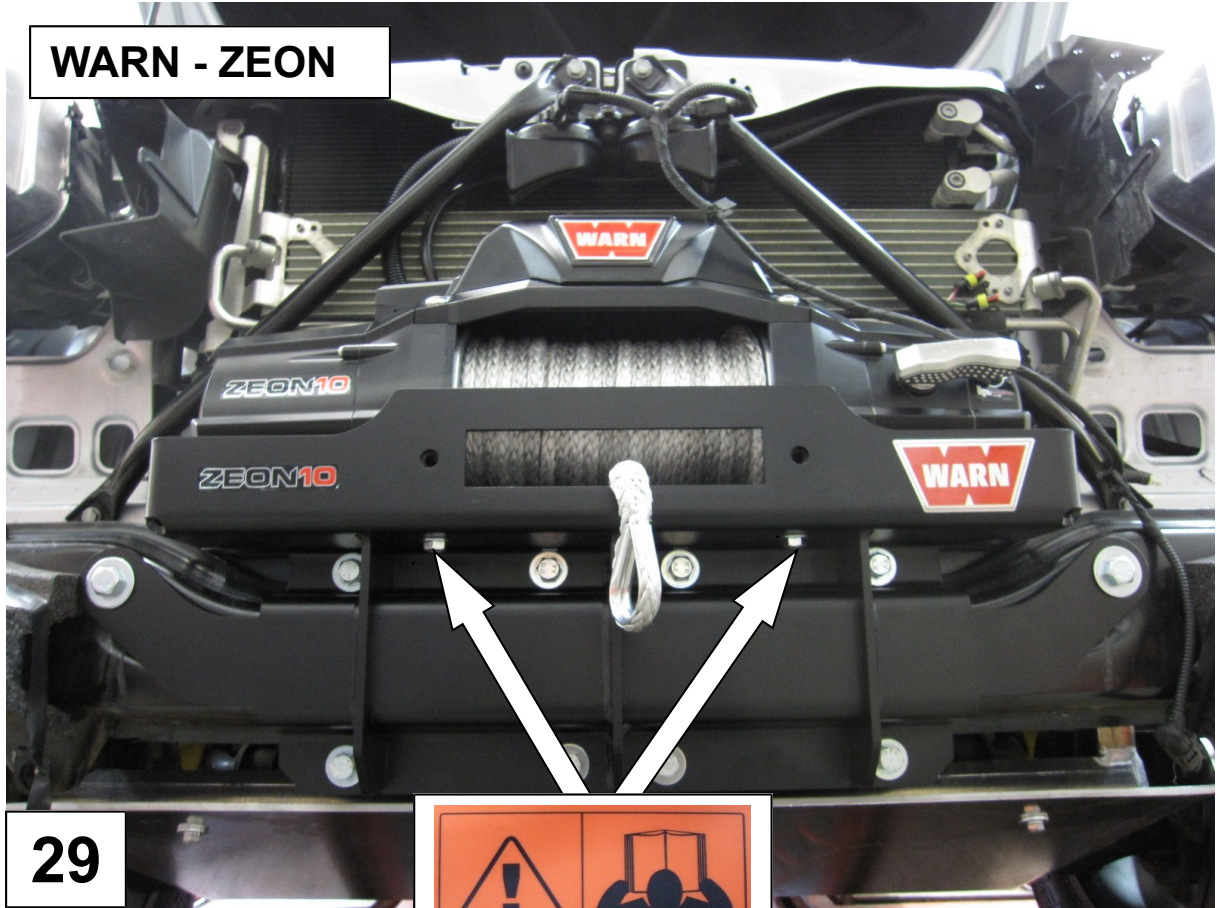

29



Befestigen Sie die Winde ,wie in der Bedienungsanleitung beschrieben !

Fix the winch as described in the winch manual!

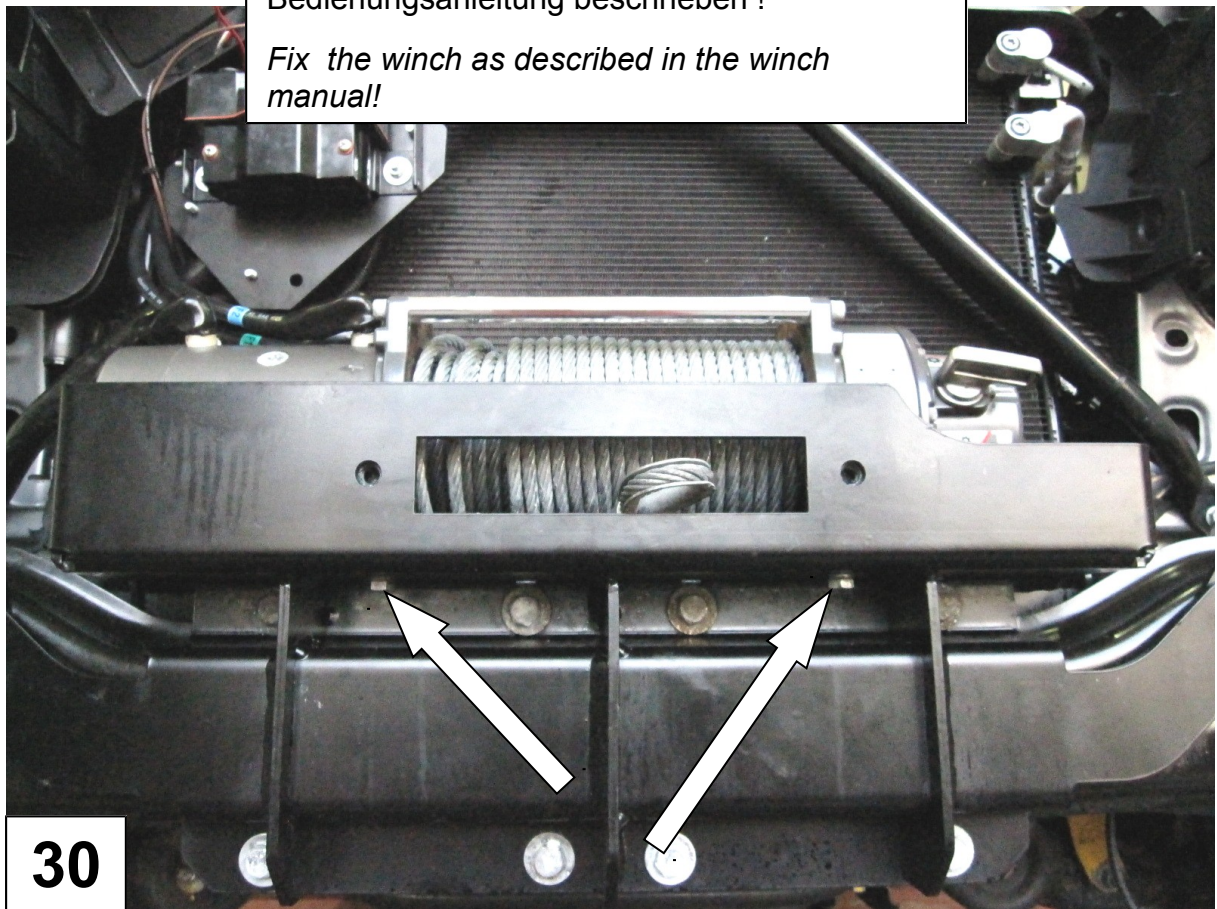

30

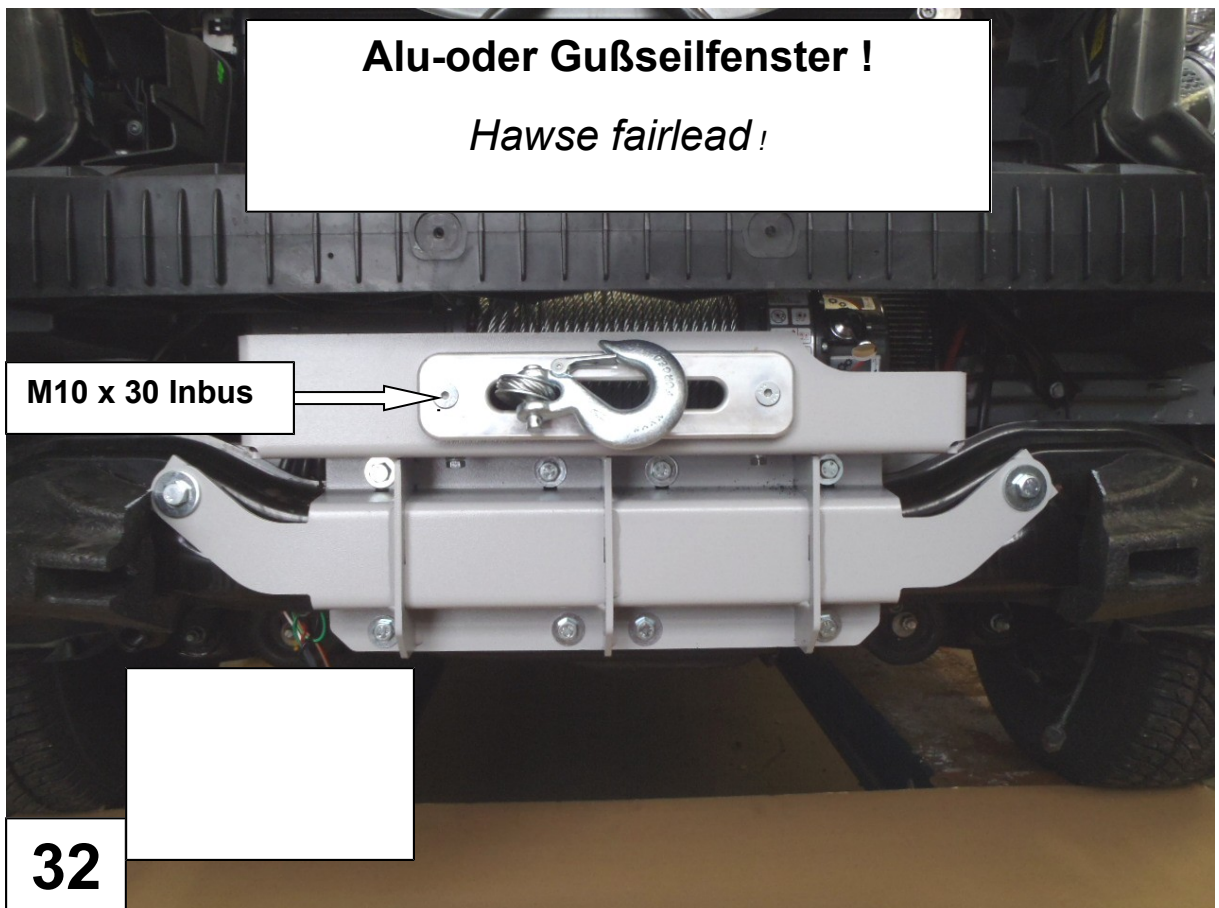
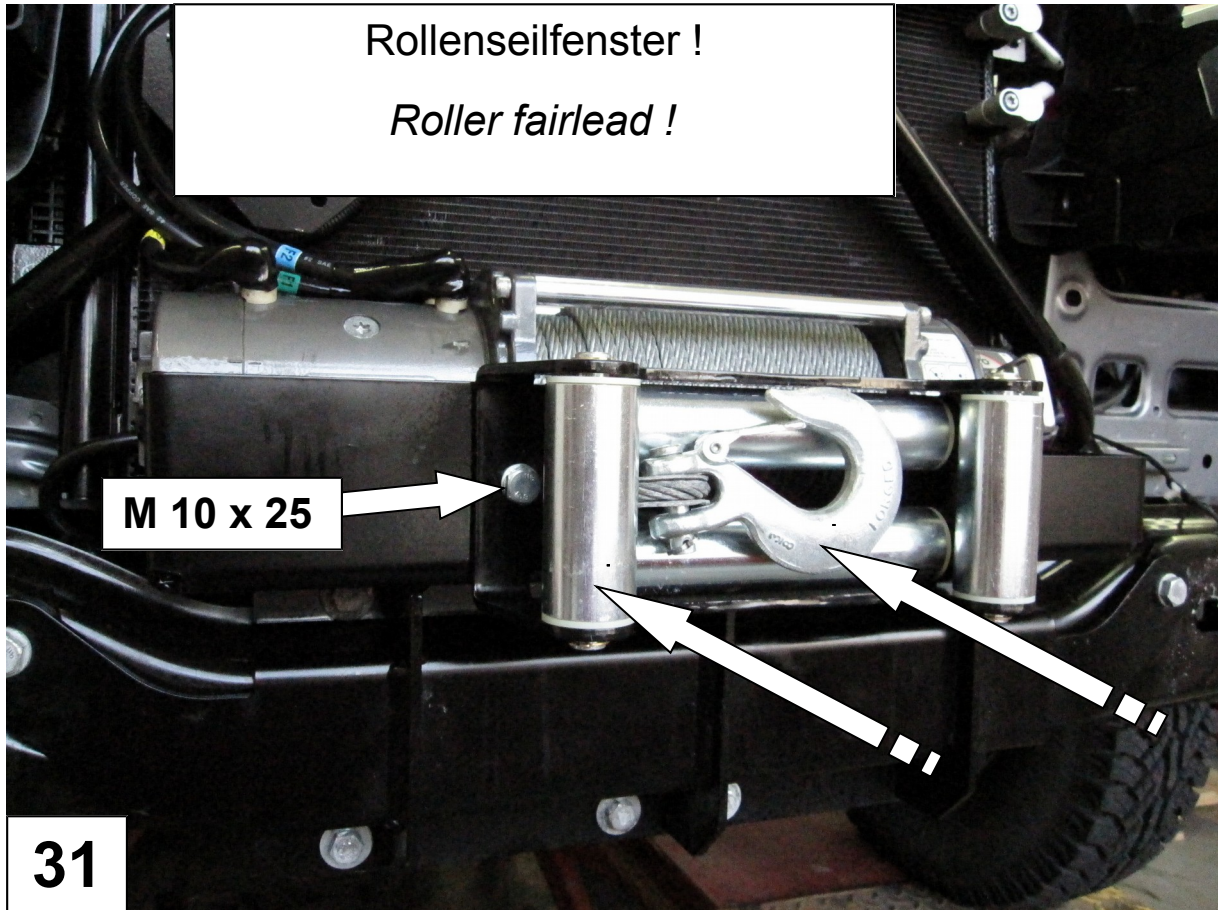

Bei Verwendung einer ZEON-Winde,
weiter mit Bild 29 !
*If you want to fit a ZEON-winch go on with
picture 29 !*

Ausschneiden siehe auch Bild 26 !
Cut out, please have a look at pict.26!

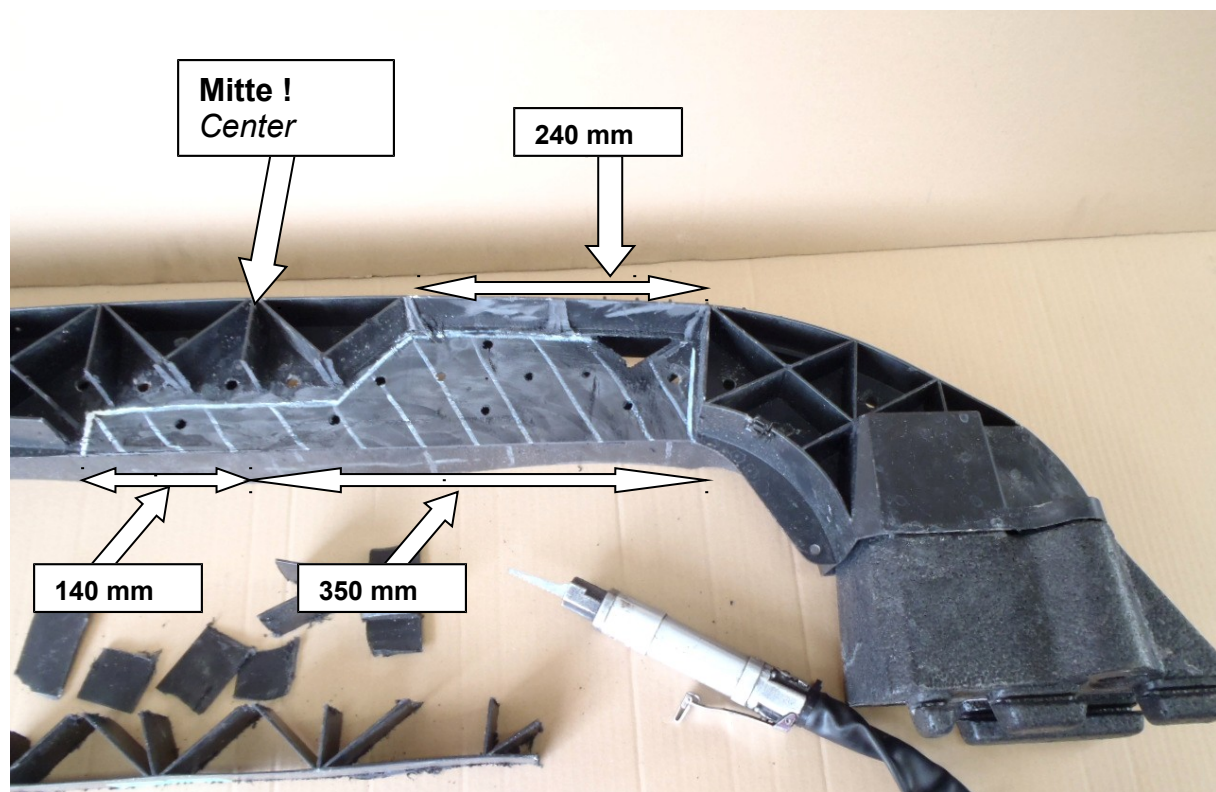
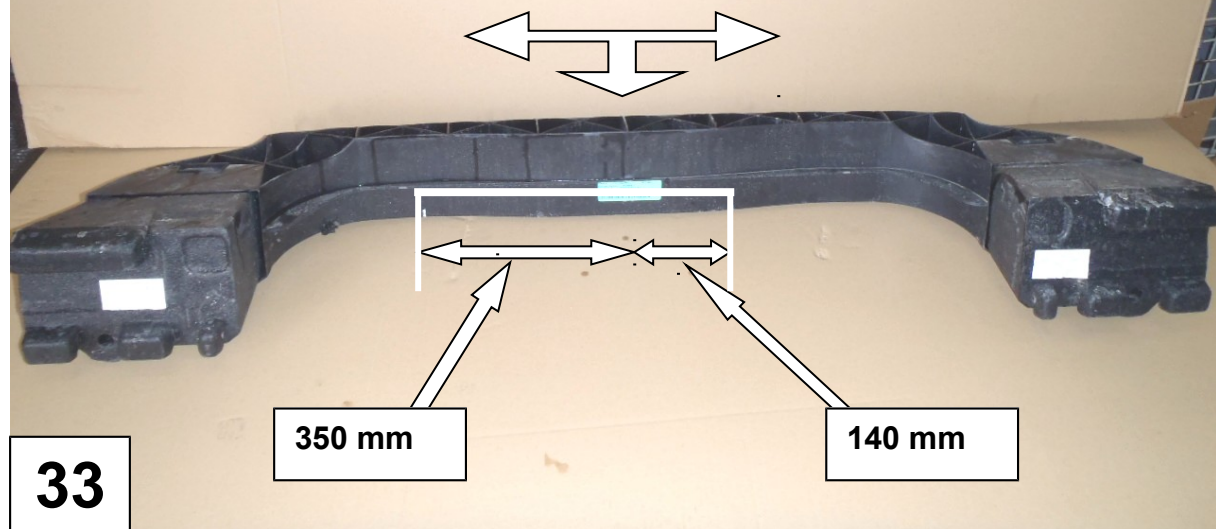

34

Weiter in Bild 37 !
Go on with picture 37 !

WARN - ZEON

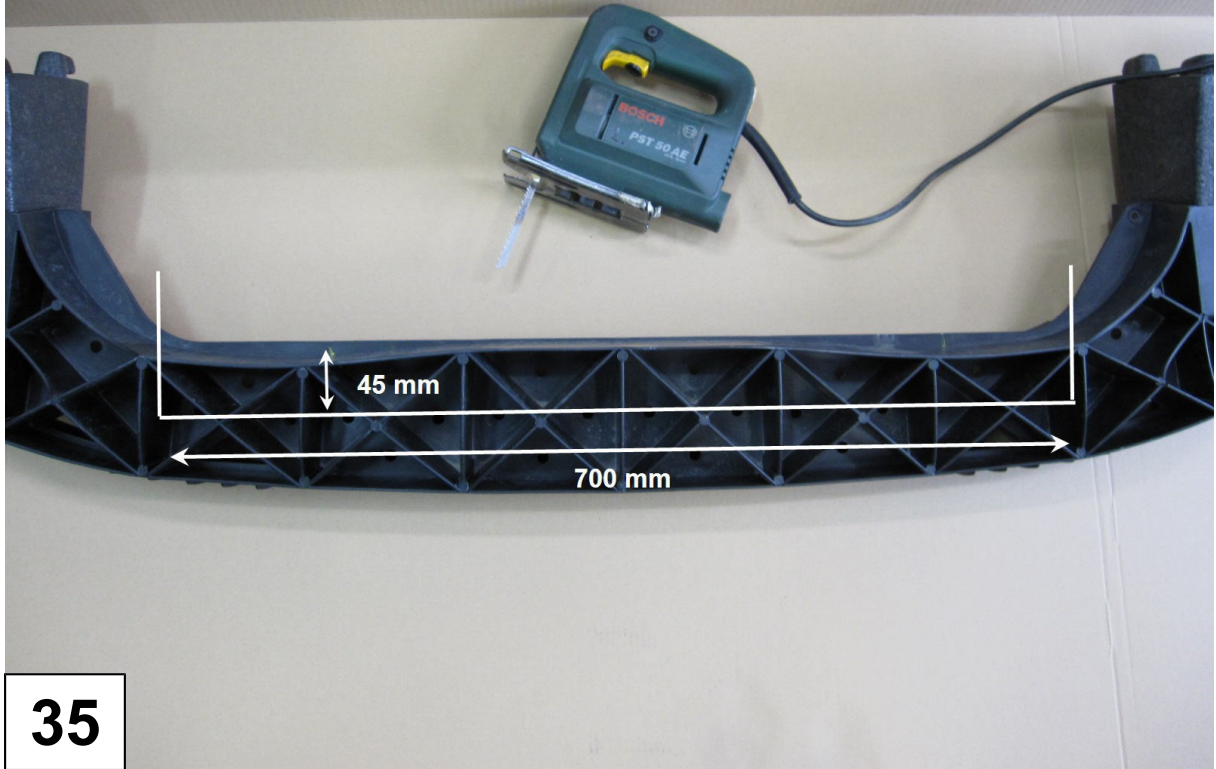

35

WARN - ZEON

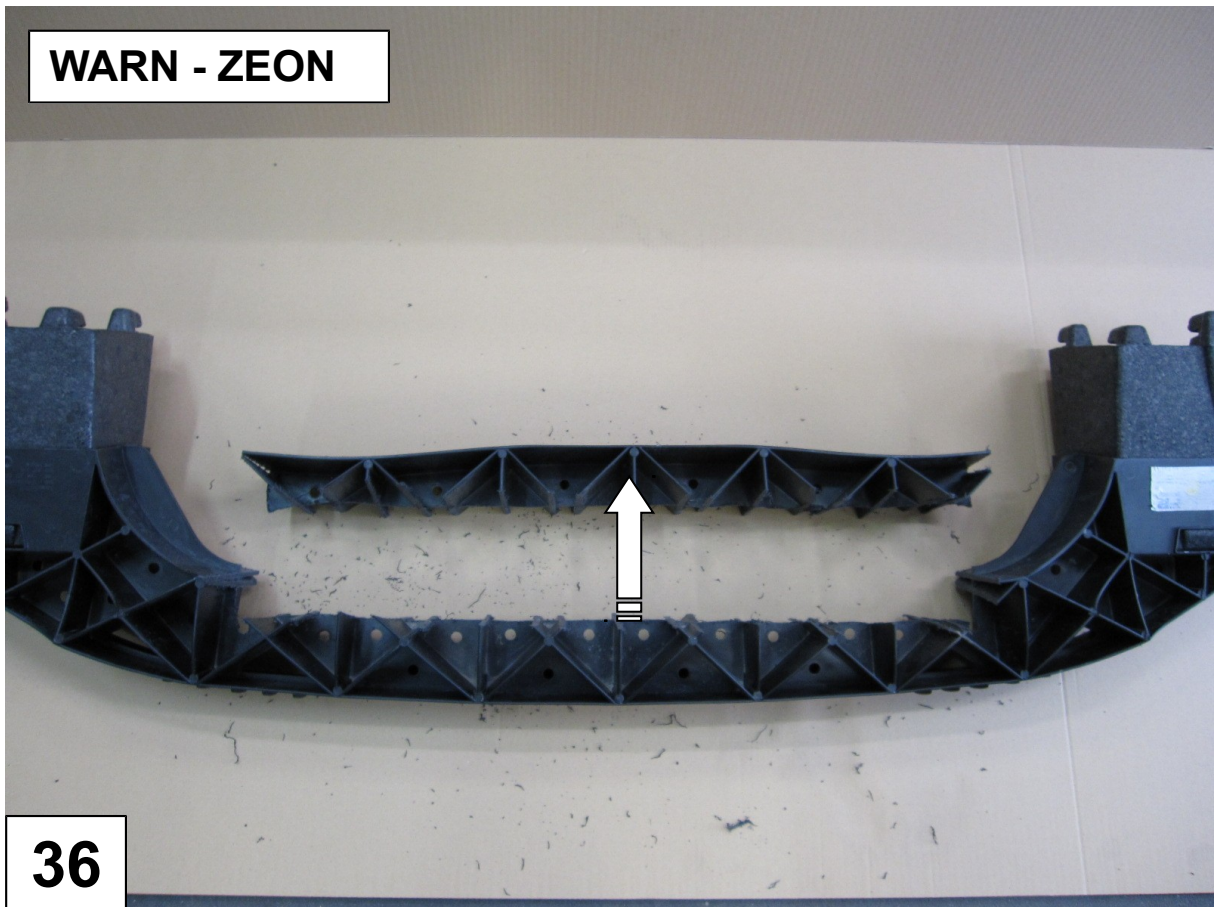

36

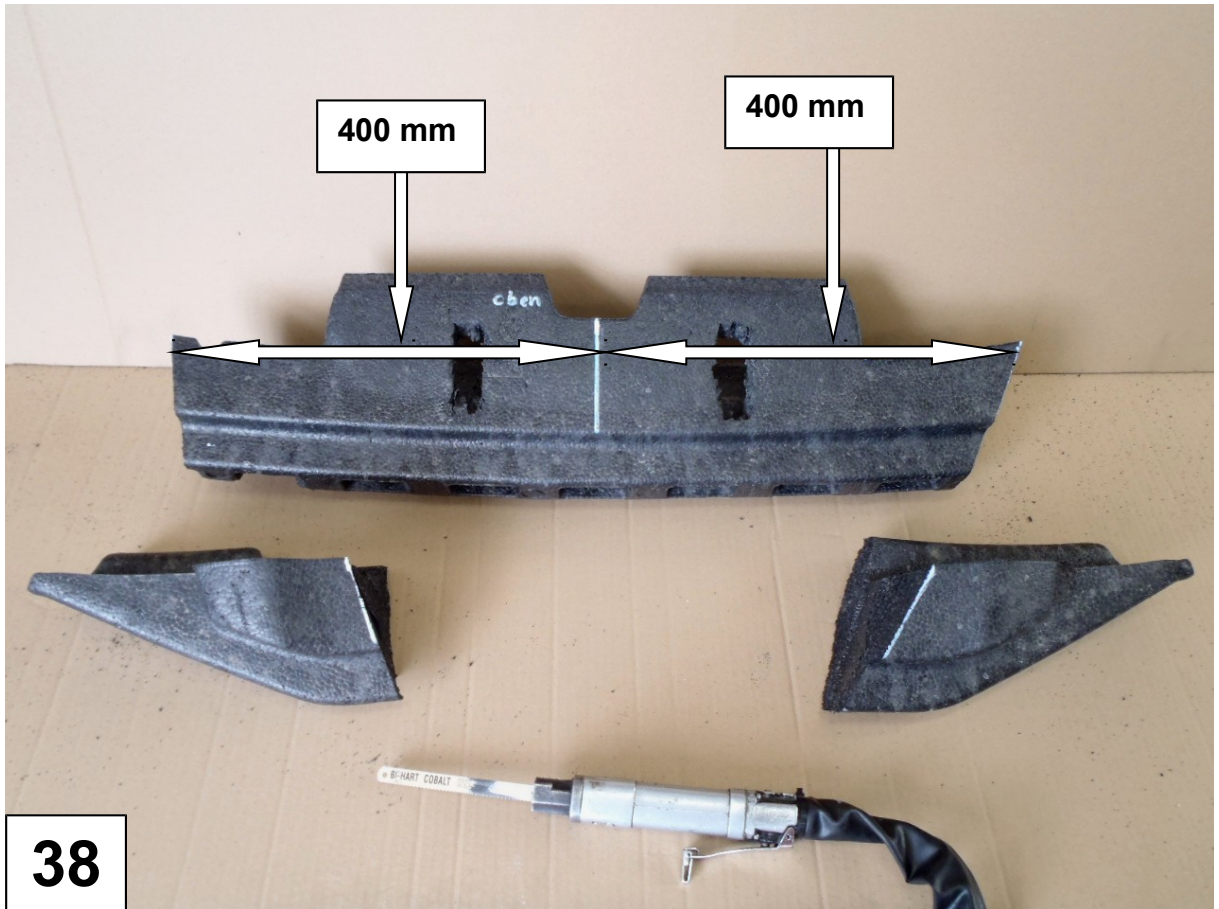
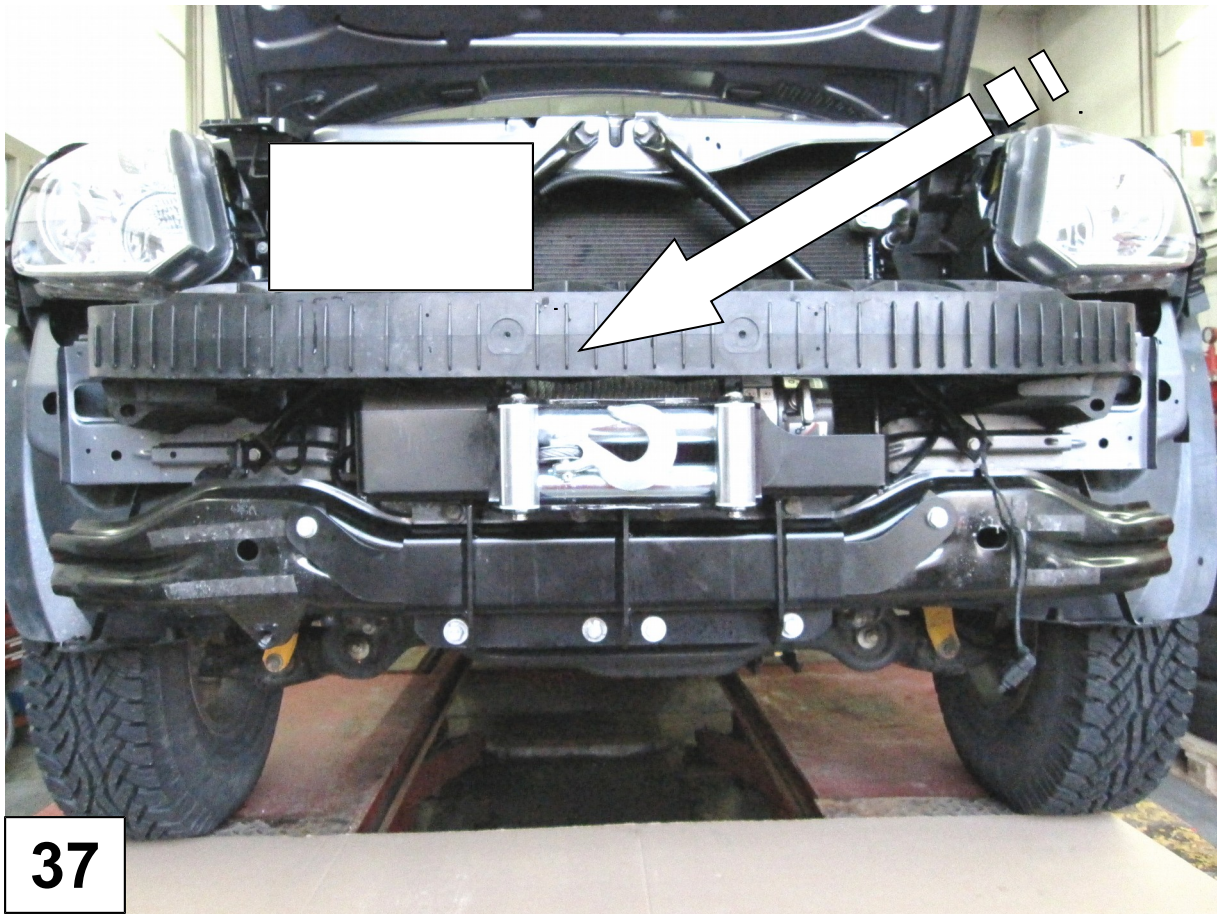



**Ausschnitt für Aluminium –
oder Gusseifenfenster !
„Trendline“ Stoßfänger**

*Cutout for hawse fairlead !
„Trendline“ bumper*

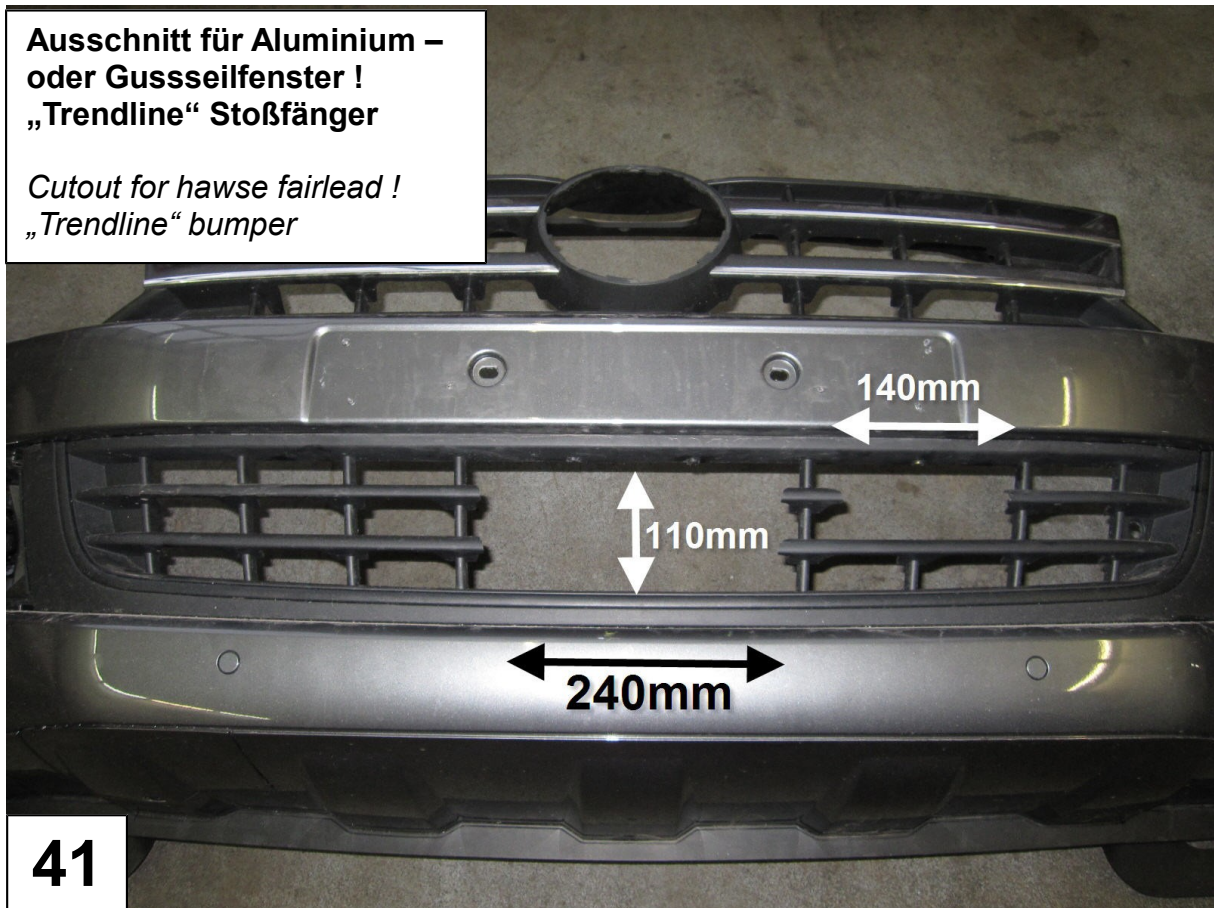

WARN - ZEON

**Ausschnitt für Aluminium –
oder Gusseifenfenster !
„Trendline“ Stoßfänger**

*Cutout for hawse fairlead !
„Trendline“ bumper*



**Ausschnitt für
Rollenseilfenster !
„Basic line“ Stoßfänger**

*Cutout for roller- fairlead !
„Basic line“ bumper*



**Ausschnitt für
Rollenseilfenster !
„Highline“ Stoßfänger**

*Cutout for roller- fairlead !
„Highline“ bumper*

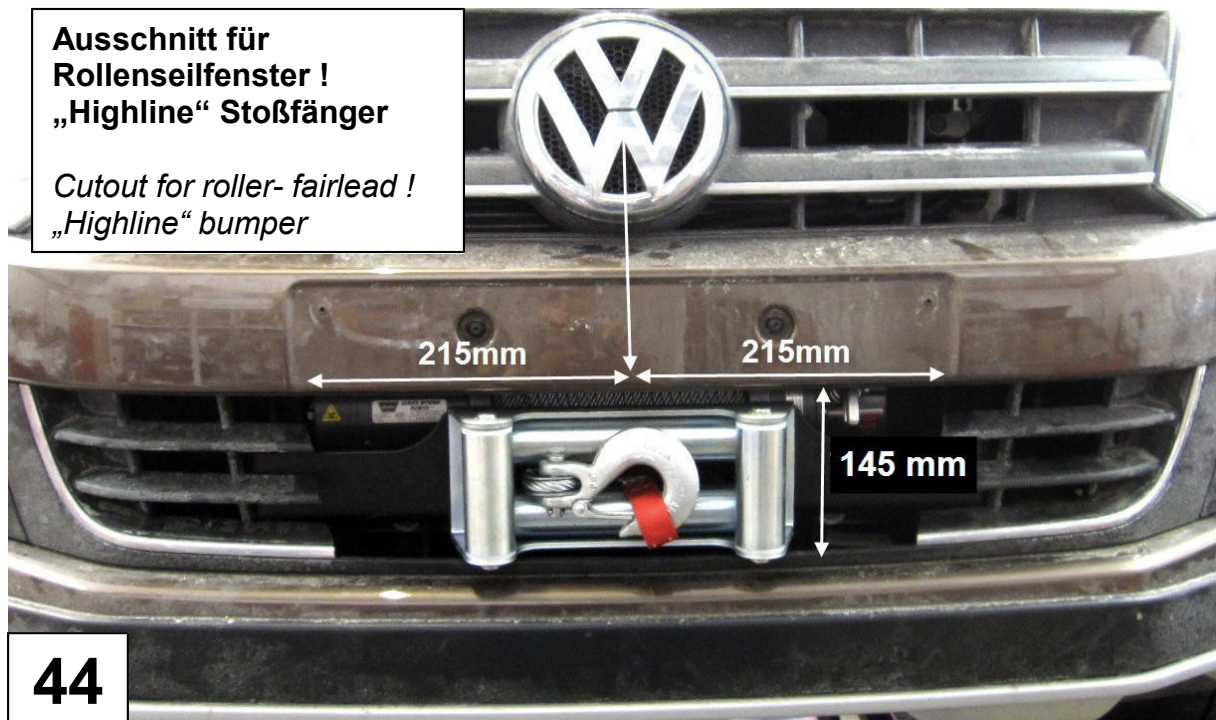

WARN - ZEON



45

**WARN
XDC + M 8000**



46

WARN
XDC + M 8000

Original
original

Bearbeitet
modified



47

WARN
XDC + M 8000

12 mm

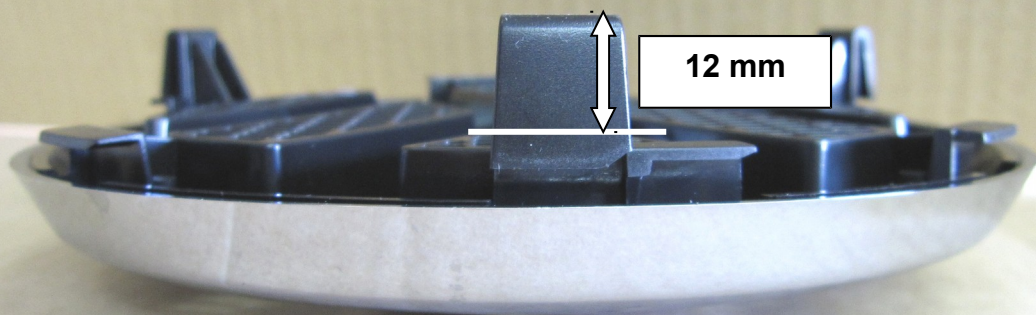

48

**WARN
XDC + M 8000**

Abrunden
round off

49

**WARN
XDC + M 8000**

TAUBENREUTHER

50

WARN
XDC + M 8000



51

WARN
XDC + M 8000



52

VW Amarok
Rollenseifensterabdeckung 15-899 zuschneiden!
Modify the roller fairlead cover !



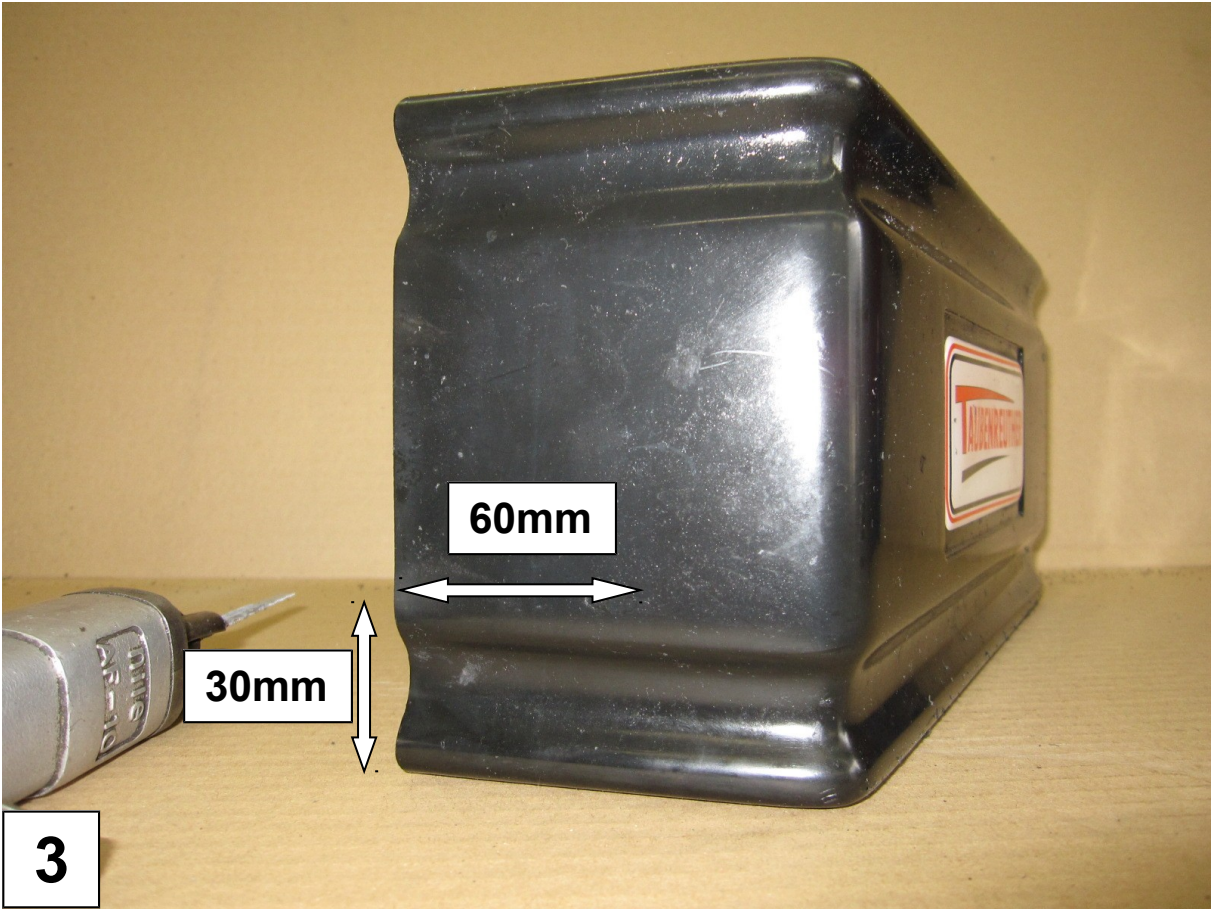

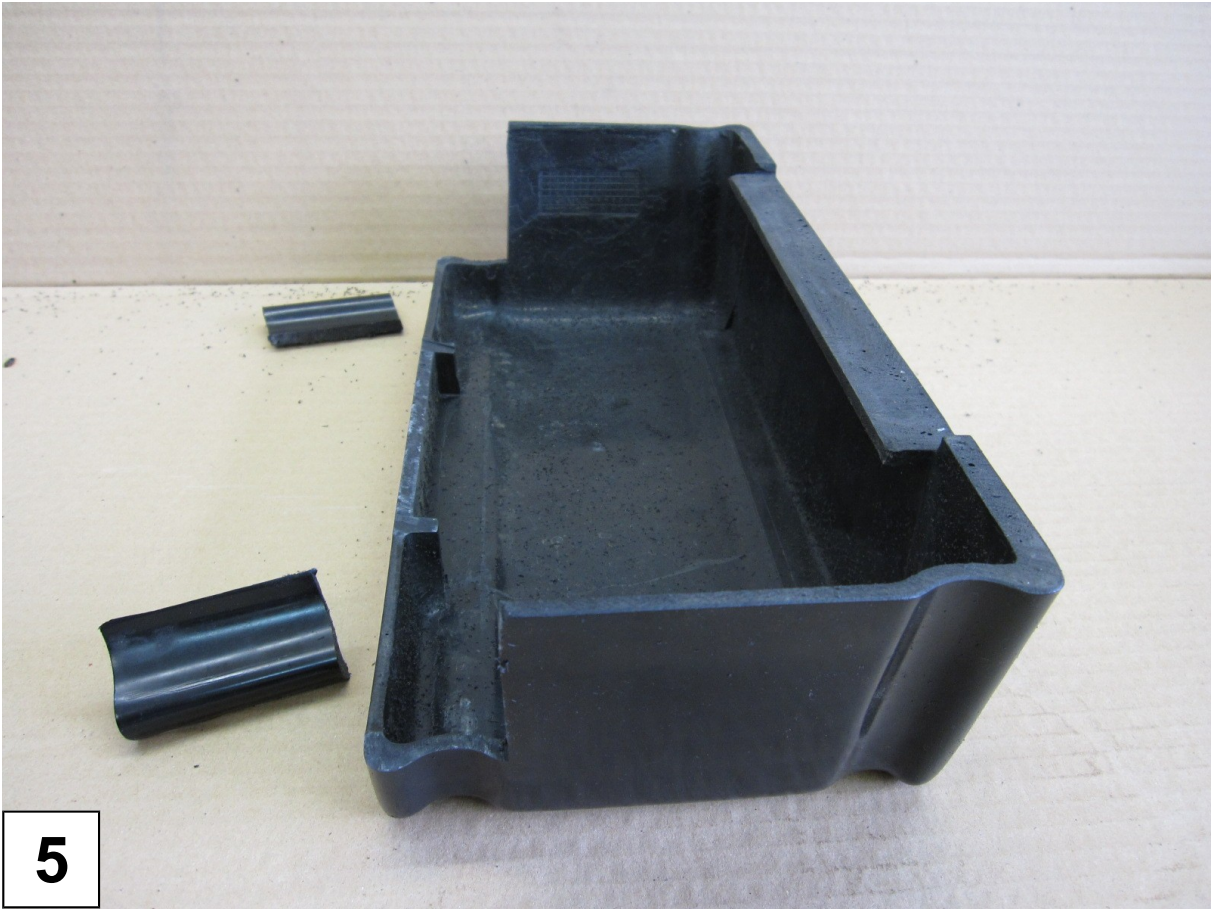

5



6