

## Anbauanleitung Seilwindenanbausatz

(wir empfehlen die Verwendung des Verlängerungskits 1-90394 für die Steckdose des Schaltkastens )

### *Fitting instruction winch mounting kit*

( we recommend to use 1-90394 contactor box socket extension kit )

## Mitsubishi L200 - KJ0T ab Bj.2016

Taubenreuther Best.nr.: 16 – 3880

Mitsubishi Best.nr.:

Z5745800 - Seilwinde 3,6to WARN M 8000 inkl.Einbaukit

Z5745900 - Seilwinde 4,1to WARN XD 9000 inkl.Einbaukit

AL: 2050-04



**Hier sehen sie den fertig montierten Seilwindenanbausatz.  
Bevor sie mit der Montage beginnen, lesen sie bitte diese Anleitung  
und das Benutzerhandbuch der Seilwinde gut durch.**

*Before you start fitting, please read and understand this instruction manual  
and the owners manual of the winch.*

**Stückliste / parts list**  
**Seilwindenanbausatz / winch mounting kit**  
**Mitsubishi L200 ab Bj.2015**

Best. Nr. 16 – 3880

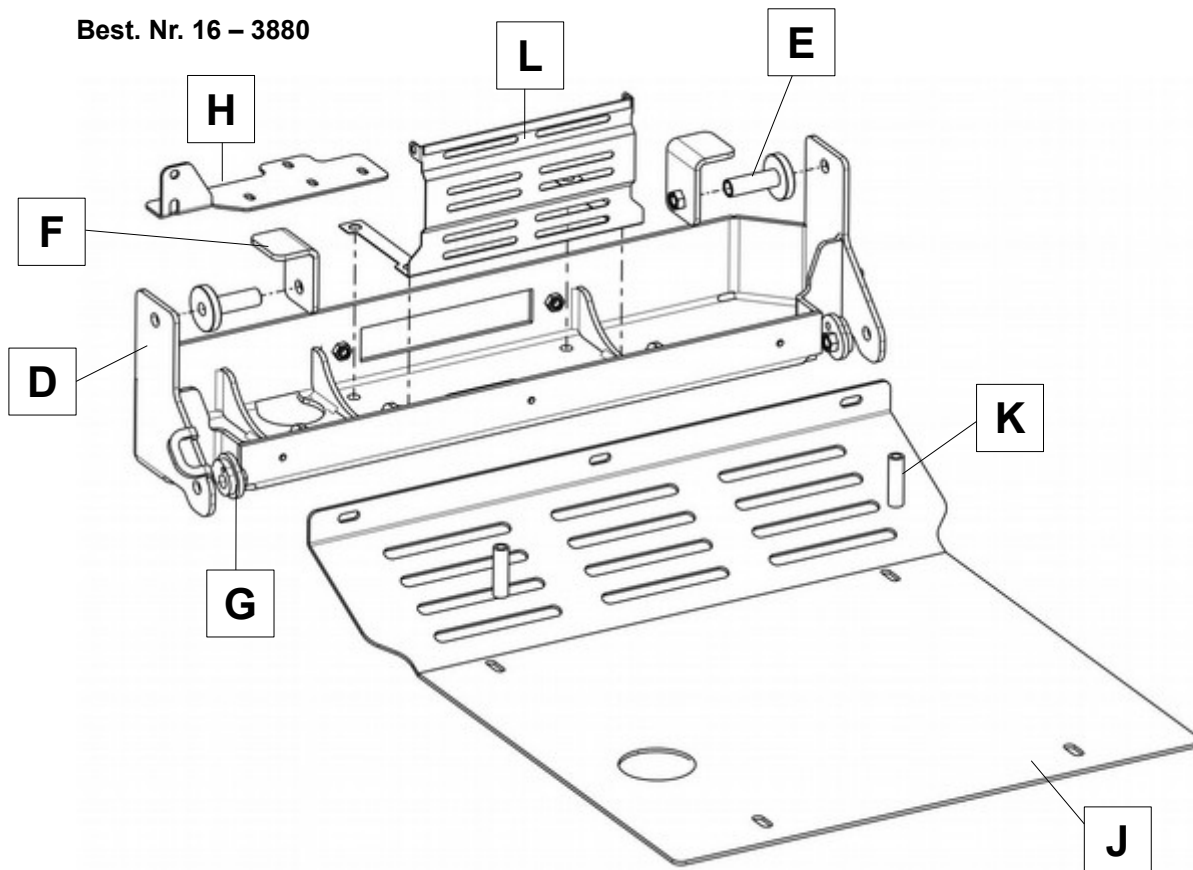

1 x Freilaufhebel 1-82463-K <i>(nicht im Bild)</i>	( A )	2 x Schraube M 12 x 100	
3 x 1100 mm Kabel 35 <sup>2</sup> schwarz mit je 2 x Kabelschuh 35 <sup>2</sup> x 8mm	( B )	2 x Schraube M 12 x 40	
1 x Kabel 1,5 <sup>2</sup> x 1000 mm mit 1 x Ringzunge rot M8 1 x Rundstecker rot 0,5-1mm	( C )	4 x U-Scheibe M 12 x 30 x 3	
1 x Seilwindenaufnahme	( D )	4 x Federring M 12	
2 x Distanzhülse	( E )	3 x Schraube M 8 x 16	
2 x Gewindegewinkel	( F )	3 x U-Scheibe M 8 x 25 x 2	
2 x Befestigungsplatte	( G )	3 x Federring M 8	
1 x Schaltkastenhalter	( H )	2 x Senkkopfschraube M 8 x 40	
1 x Rundsteckülse rot 0,5-1mm	( i )	2 x Senkkopfschraube M 8 x 80	
1 x Unterfahrerschutz	( J )	4 x Senkscheibe 8,4	( M )
2 x Distanzrohr	( K )	<i>(nicht im Bild)</i>	
1 x 16-0512, Schutzblech hinten	( L )	4 x Mutter M 8	
<b>1 x Anbauanleitung AL 2050</b>		2 x U-Scheibe M 8	
<b>1 x Teilegutachten</b>		2 x Federring M 8	
<b>1 x Aufkleber Kennzeichnung</b>			

  

Schrauben Anzugsmomente	
Schraubengröße	Güteklasse - 8.8
M6	10 Nm
M8	25 Nm
M10	50 Nm
M12	87 Nm
M14	138 Nm
M16	210 Nm



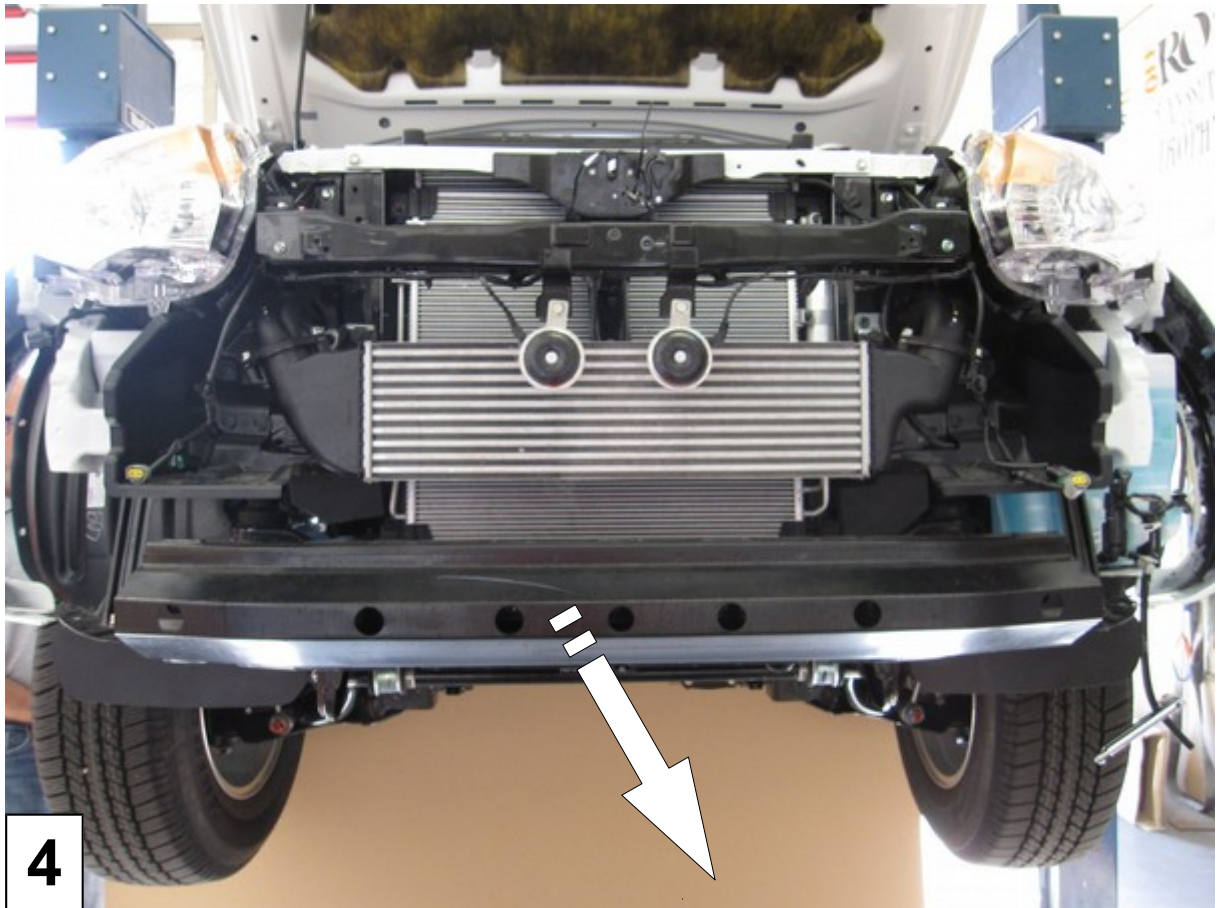



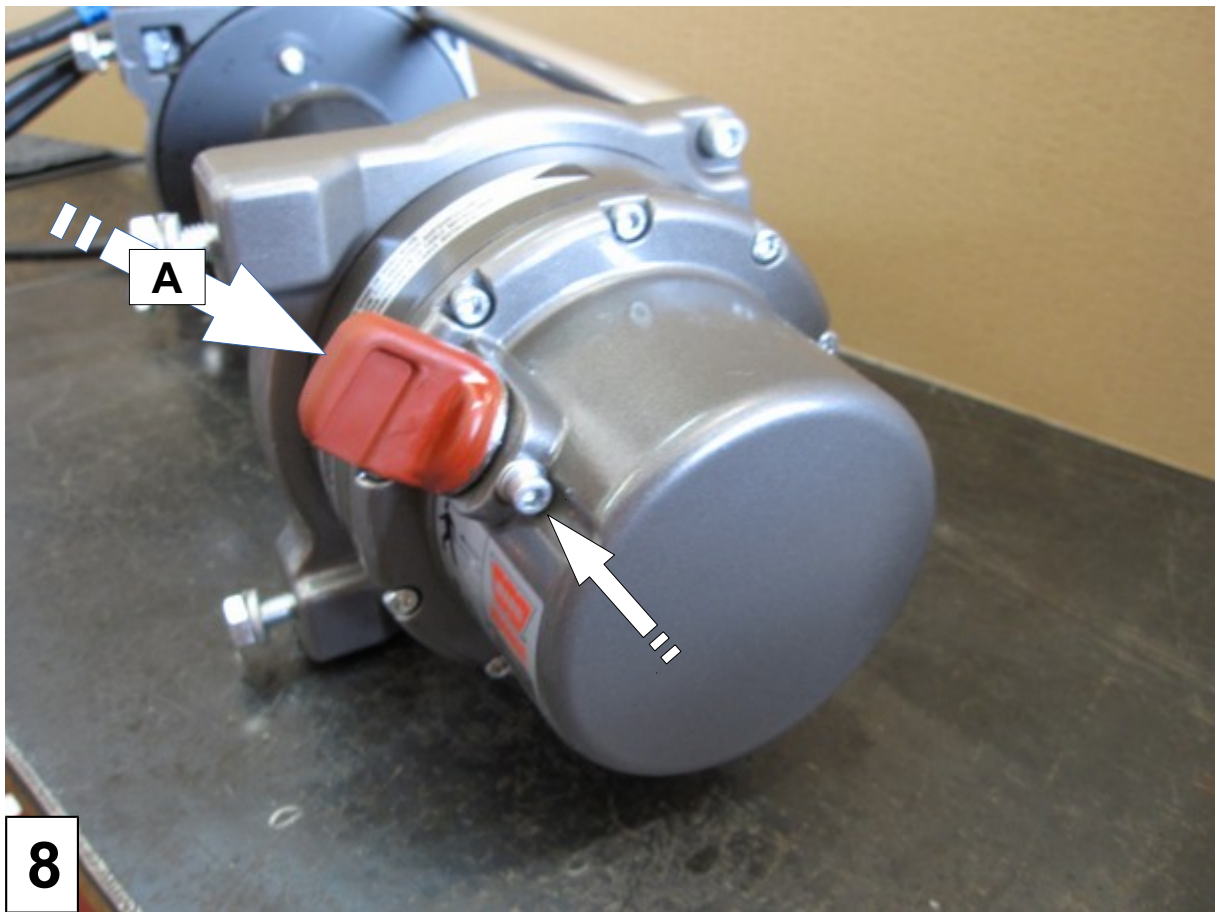

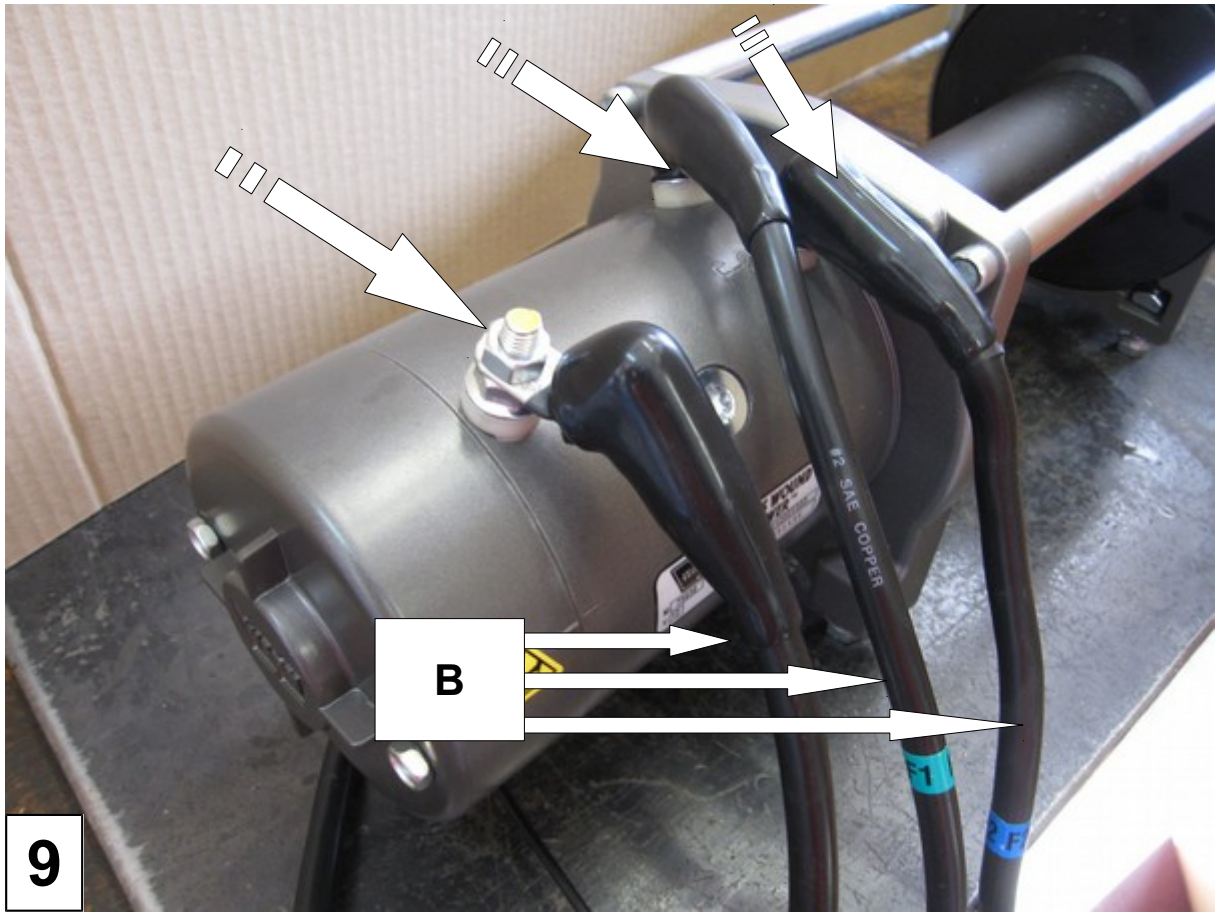

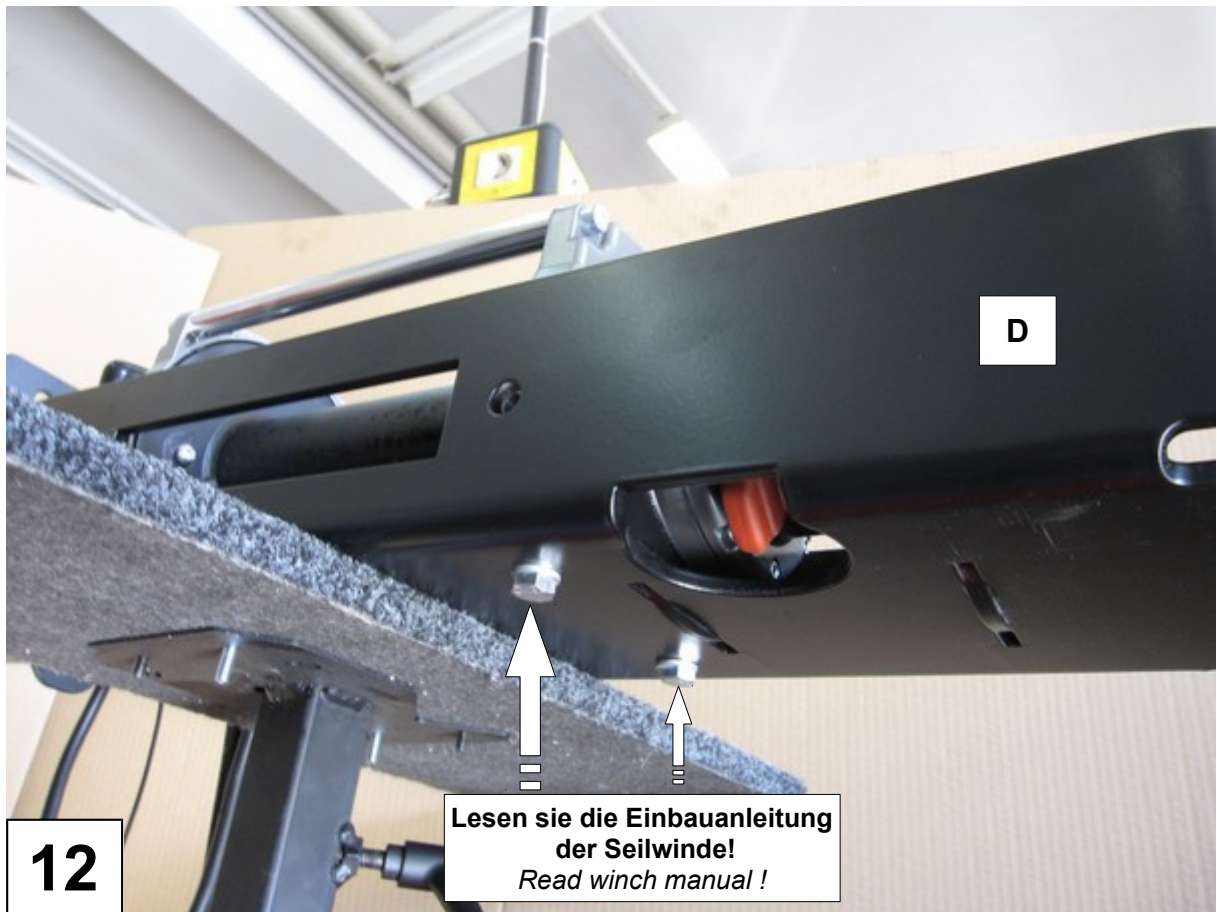
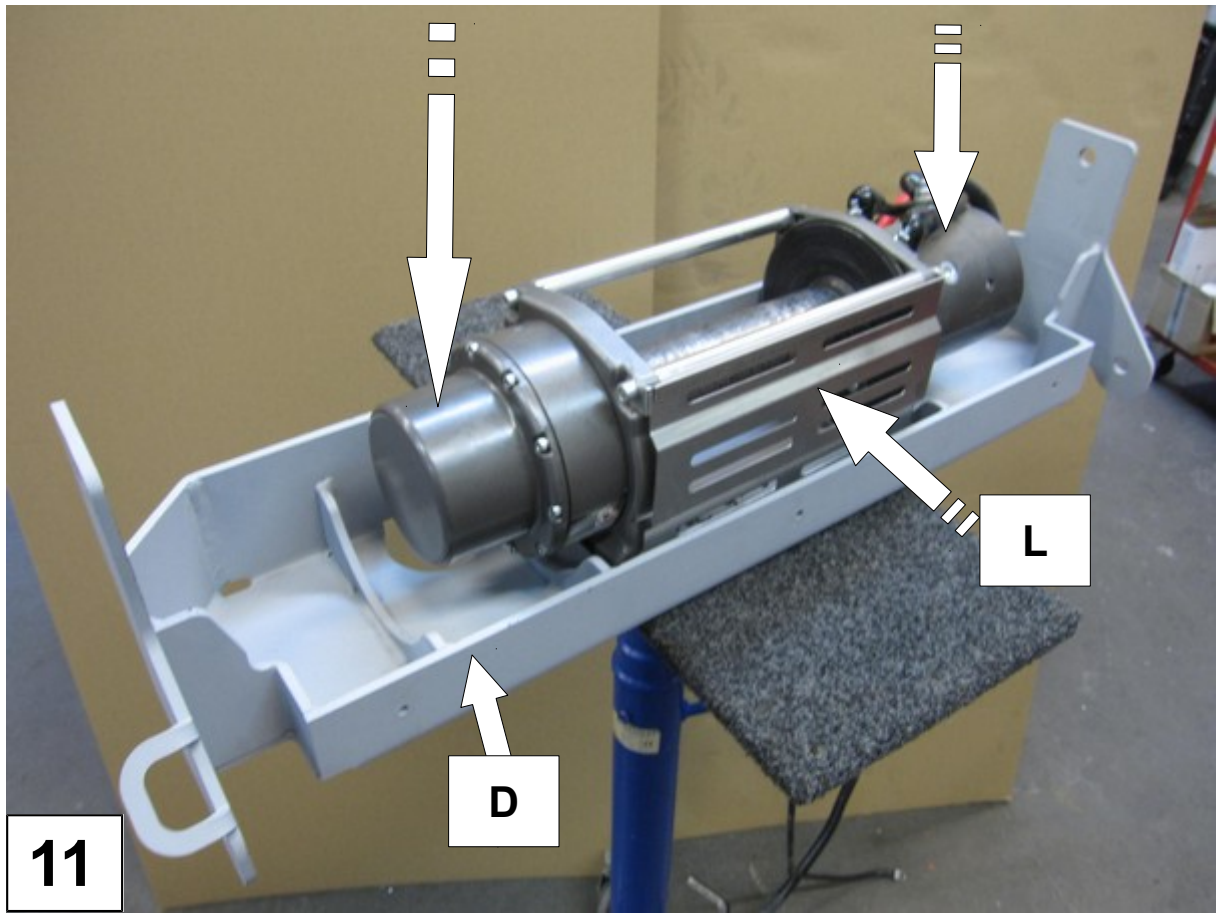



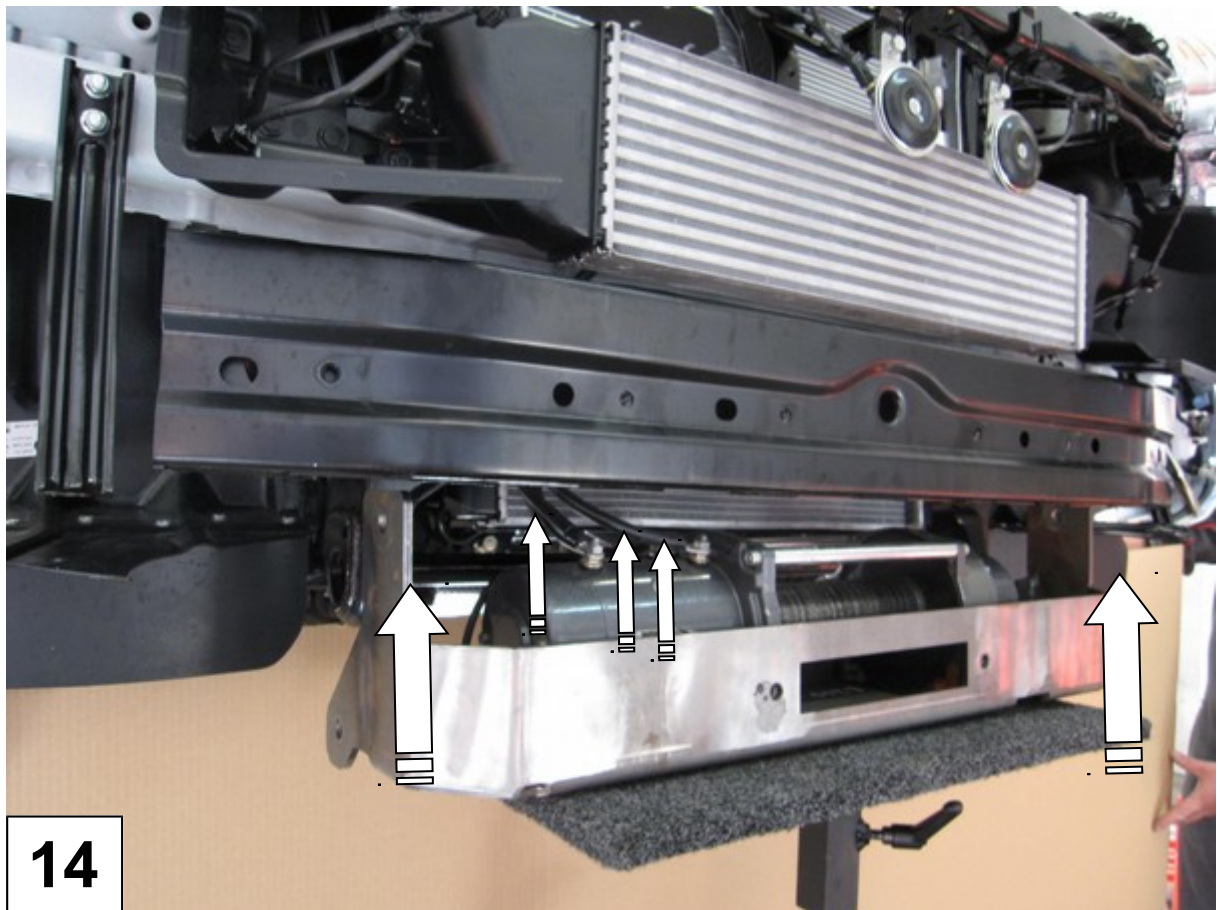
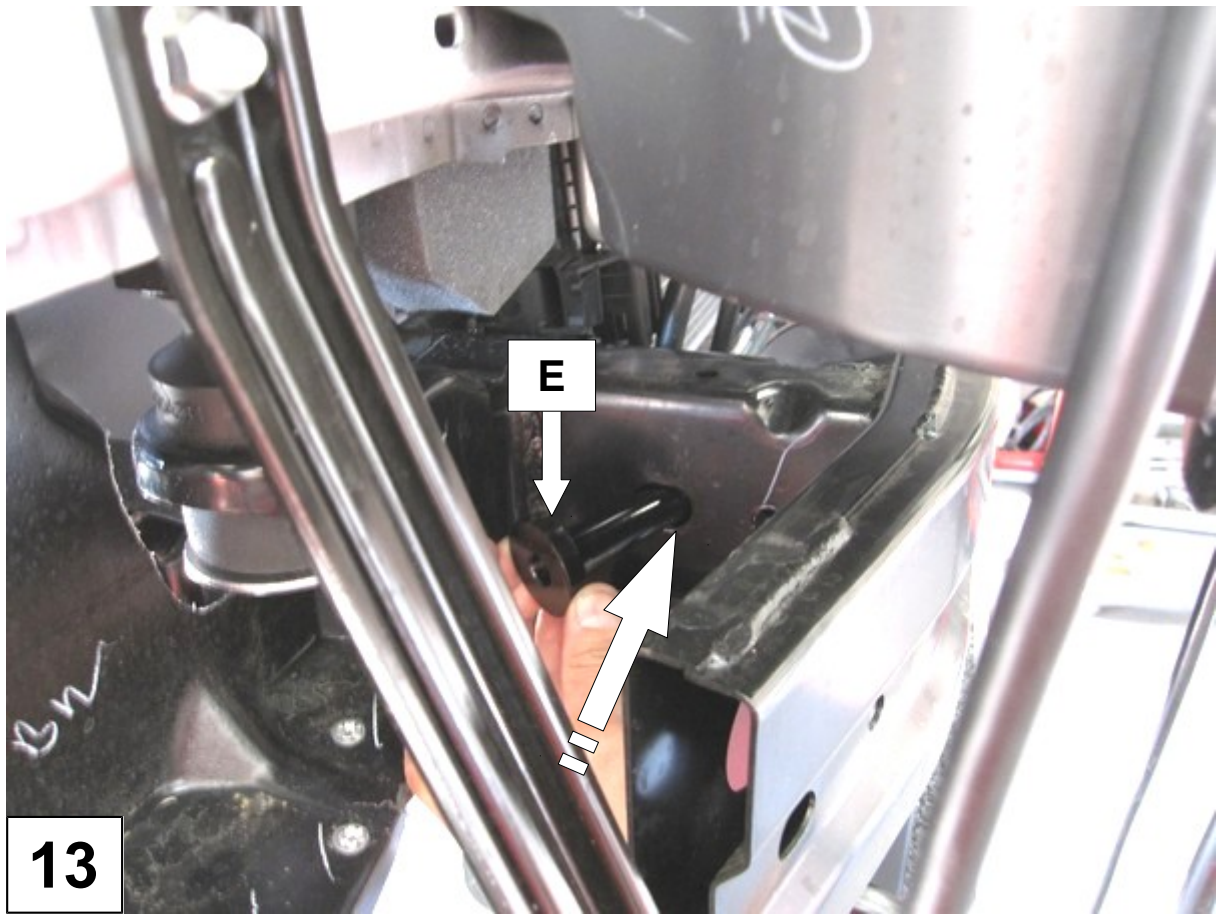

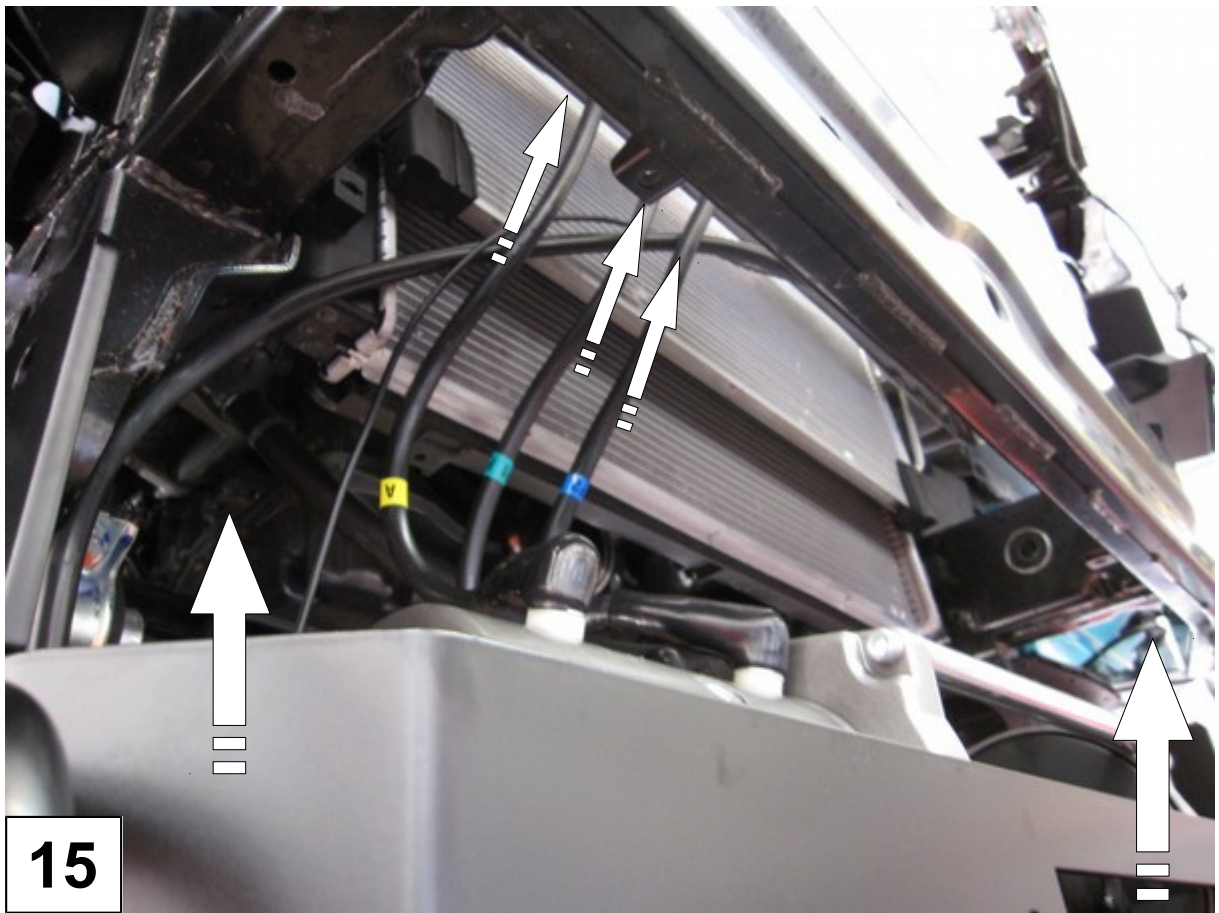

**15**

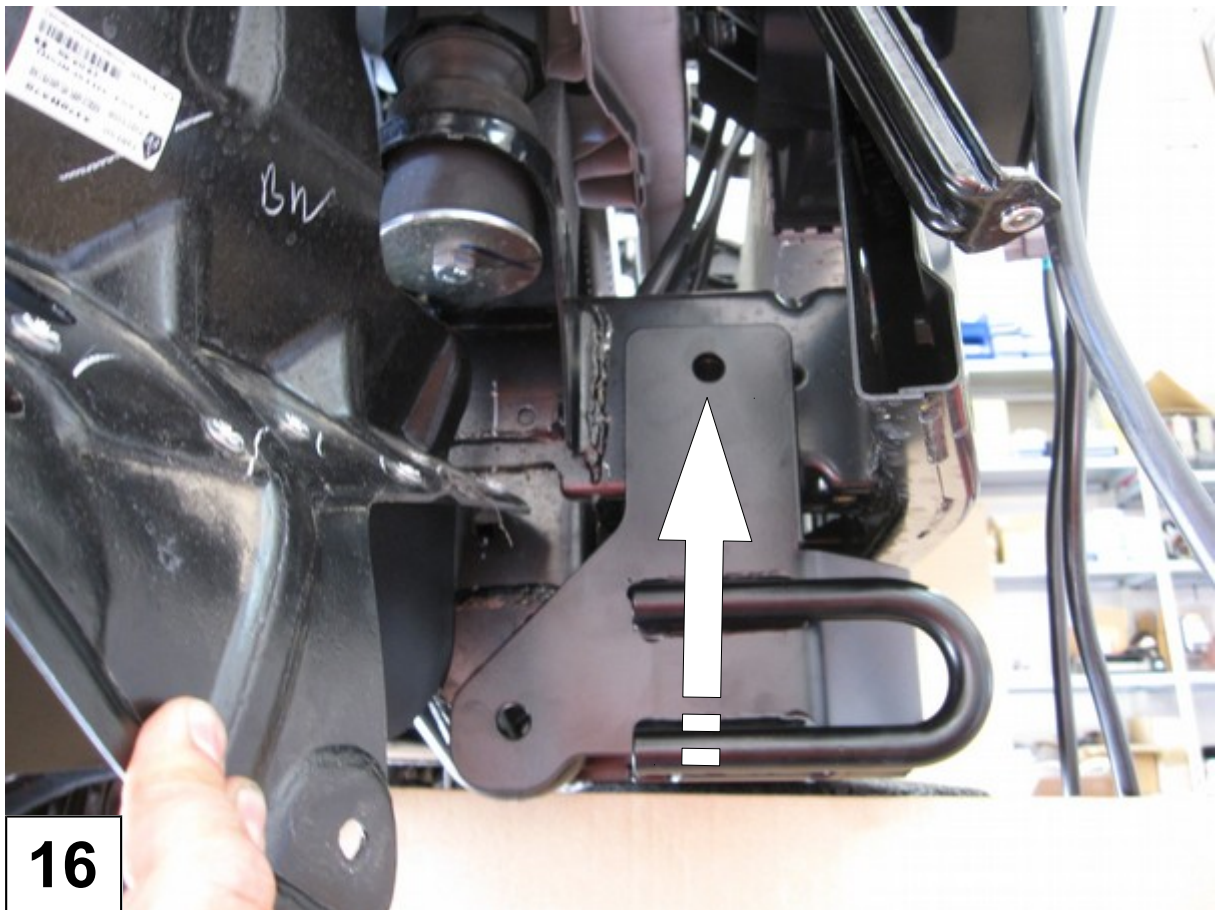

**16**

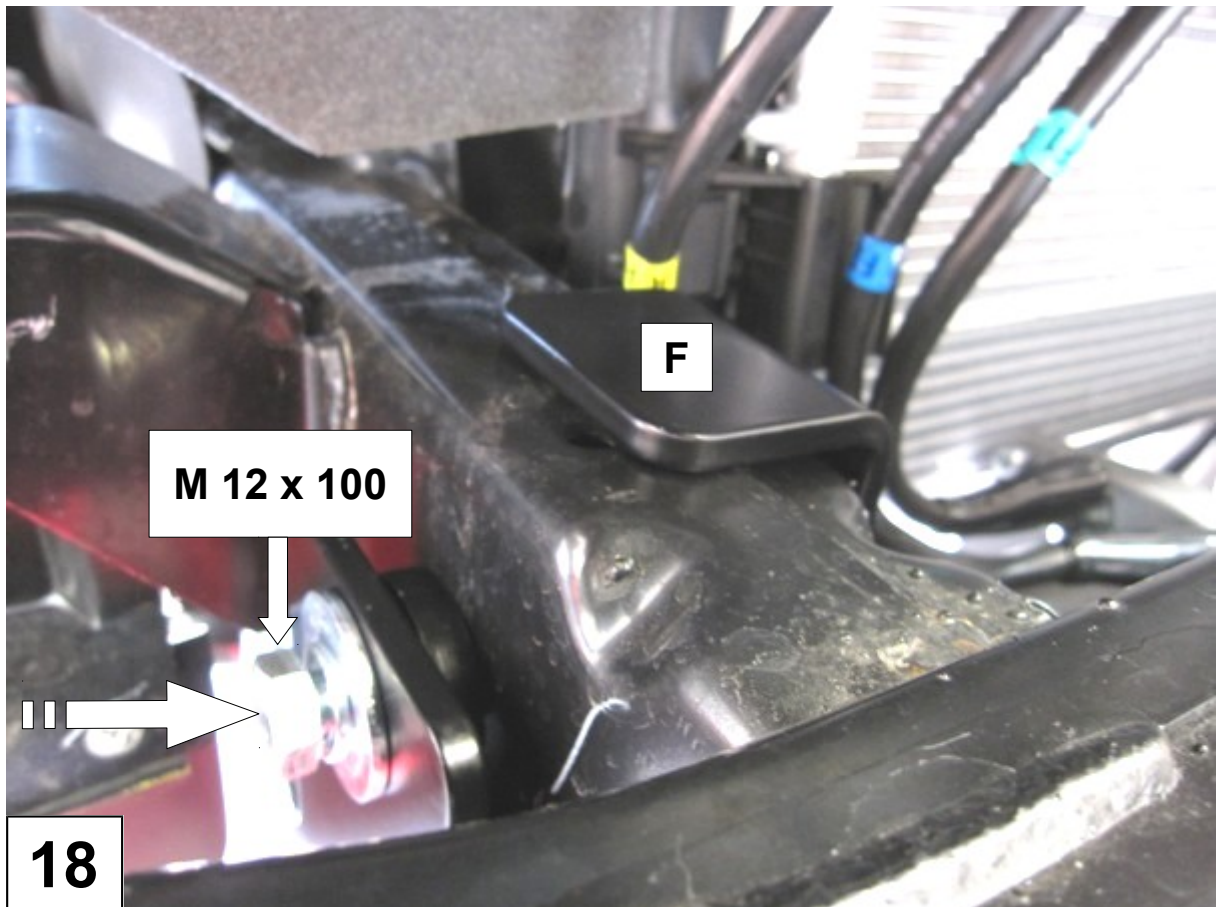
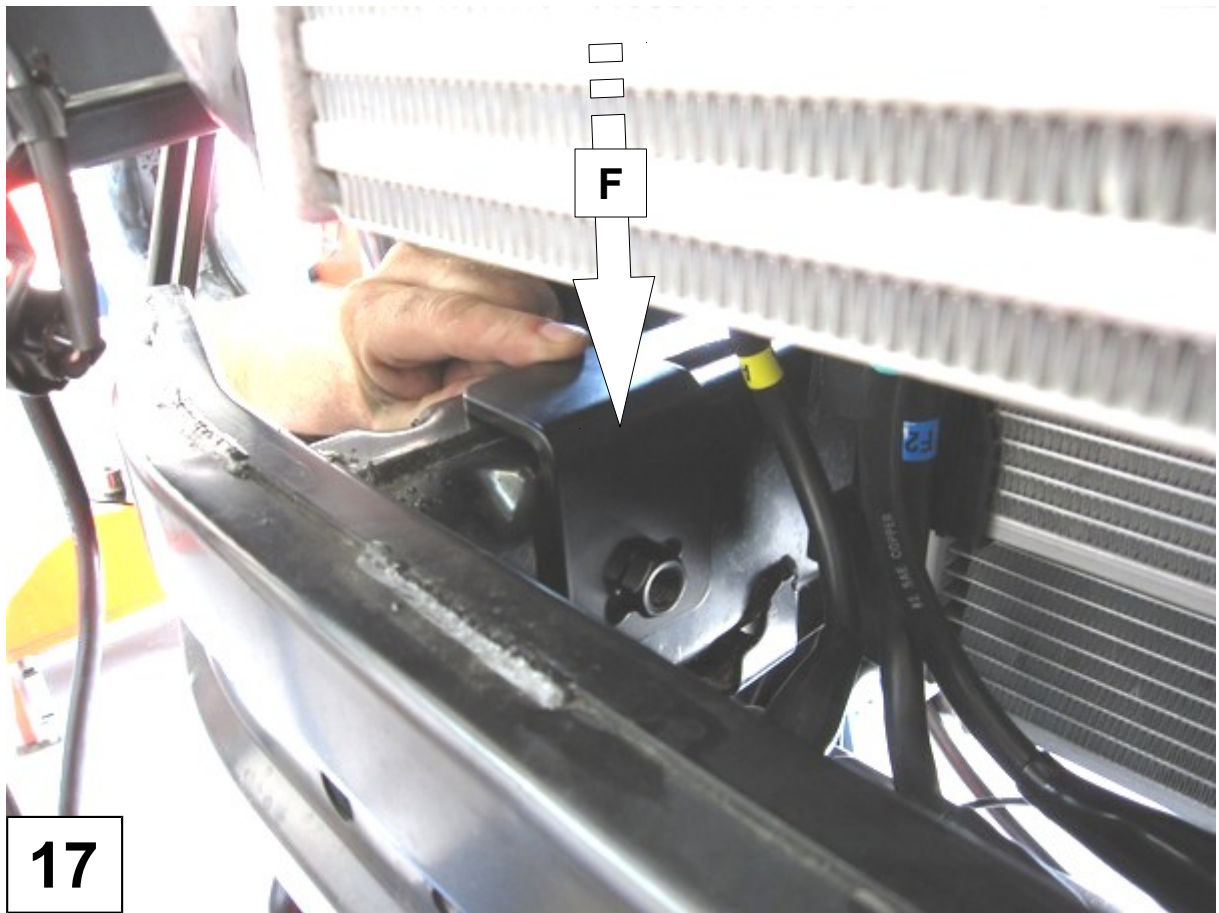

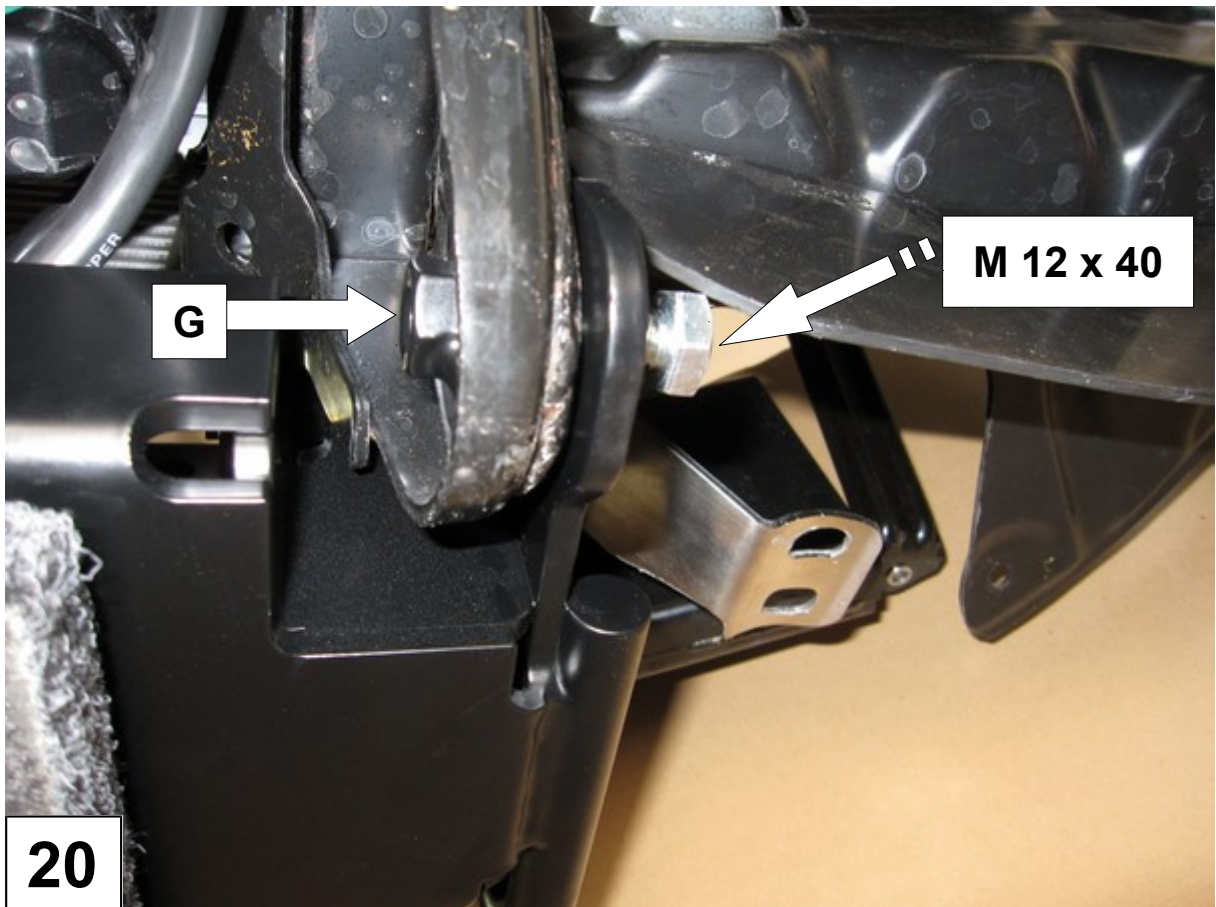
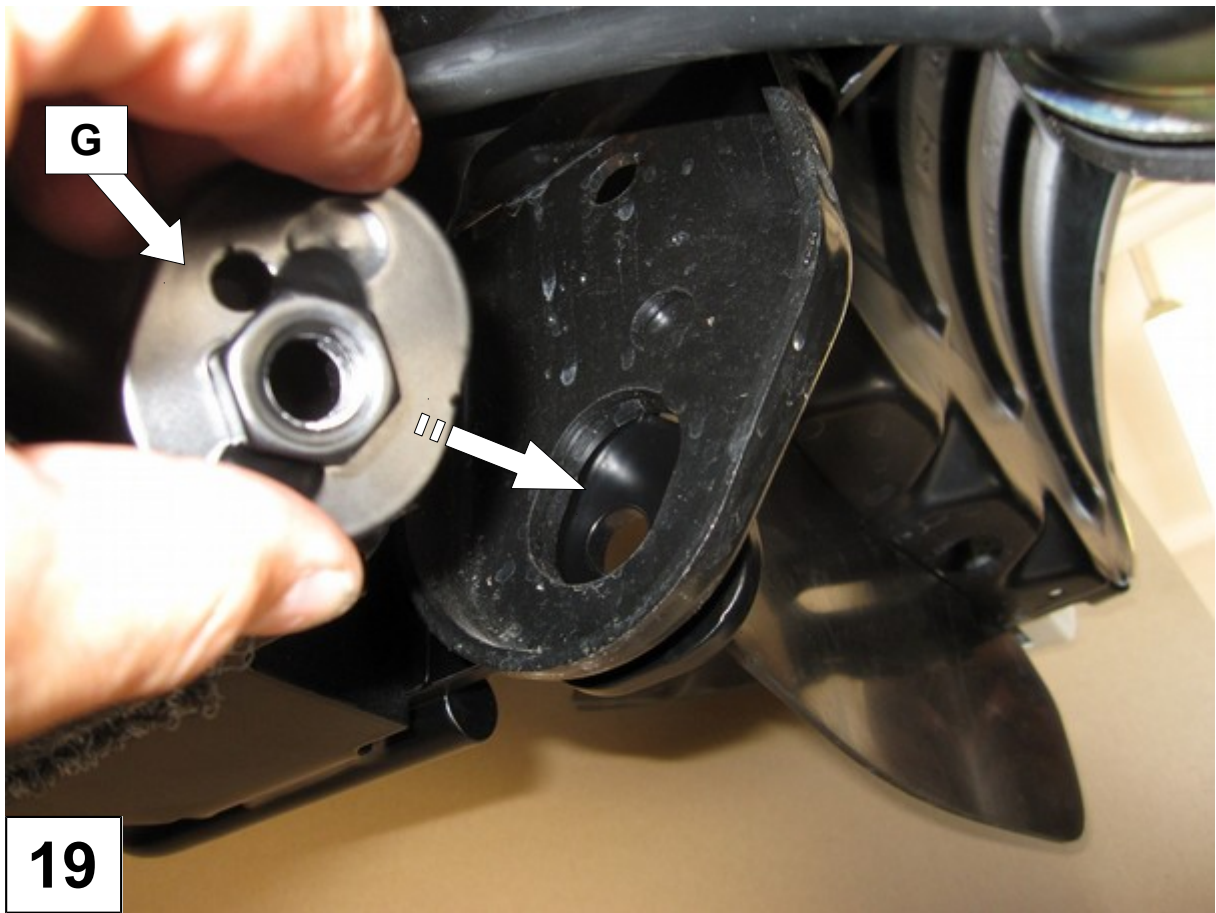

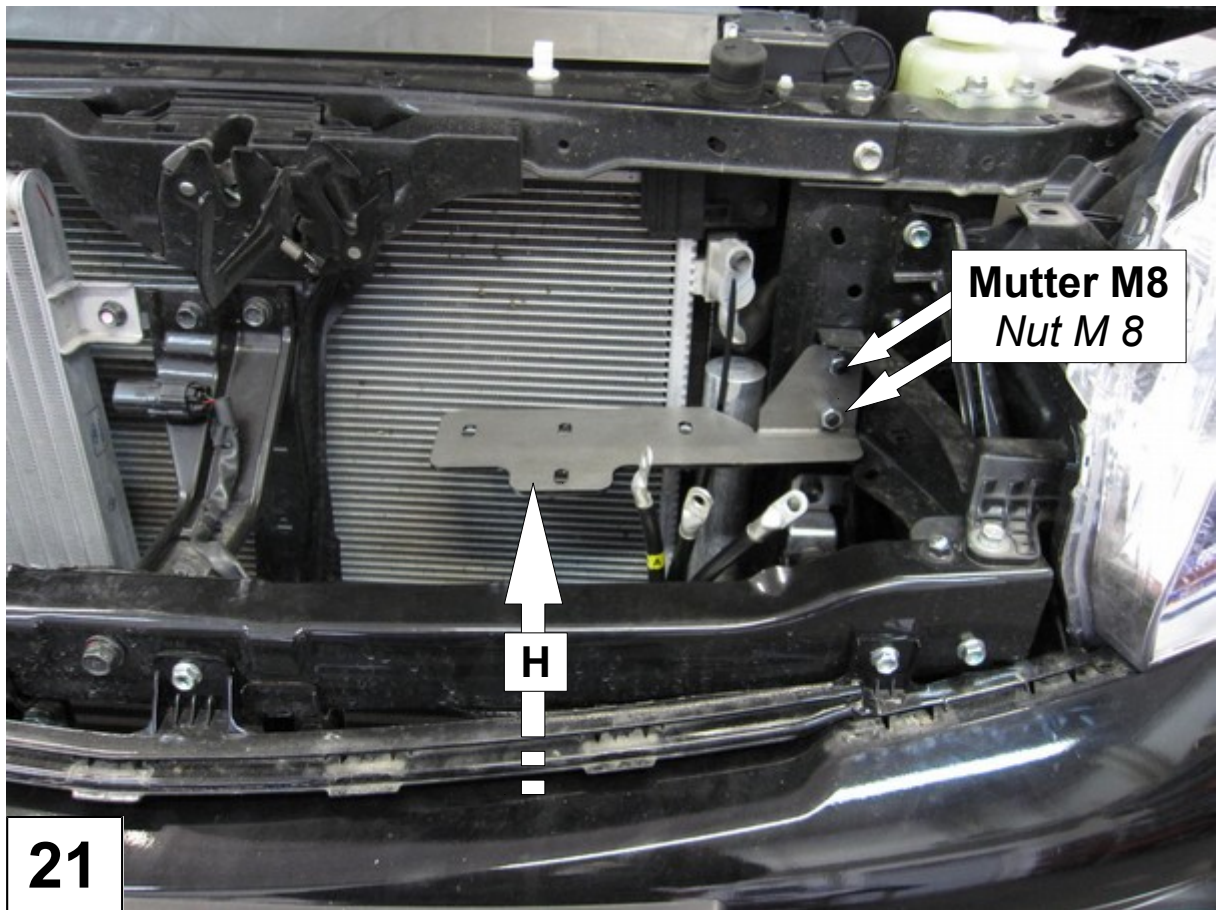

21

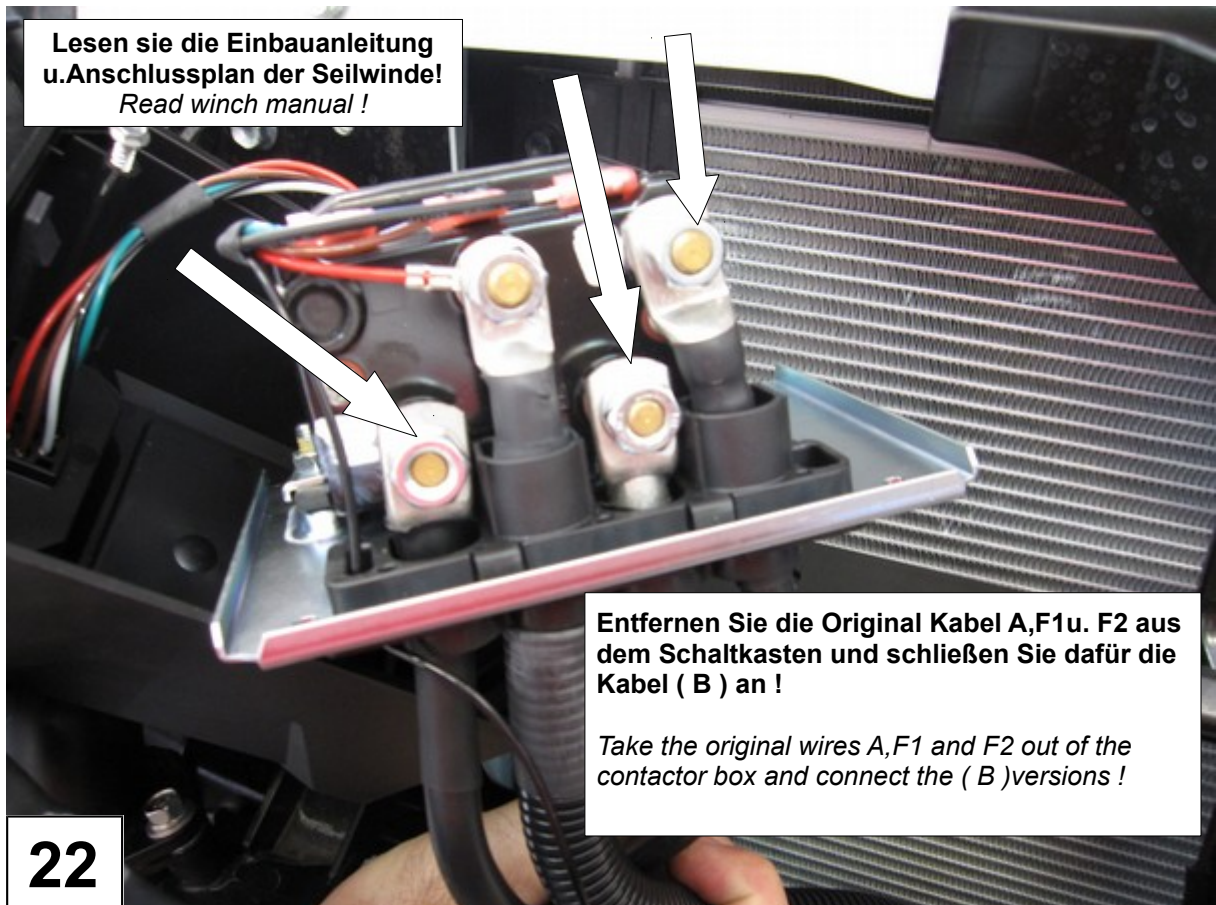

Lesen sie die Einbauanleitung  
u. Anschlussplan der Seilwinde!  
*Read winch manual !*

Entfernen Sie die Original Kabel A,F1u. F2 aus  
dem Schaltkasten und schließen Sie dafür die  
Kabel ( B ) an !

*Take the original wires A,F1 and F2 out of the  
contactor box and connect the ( B ) versions !*

22

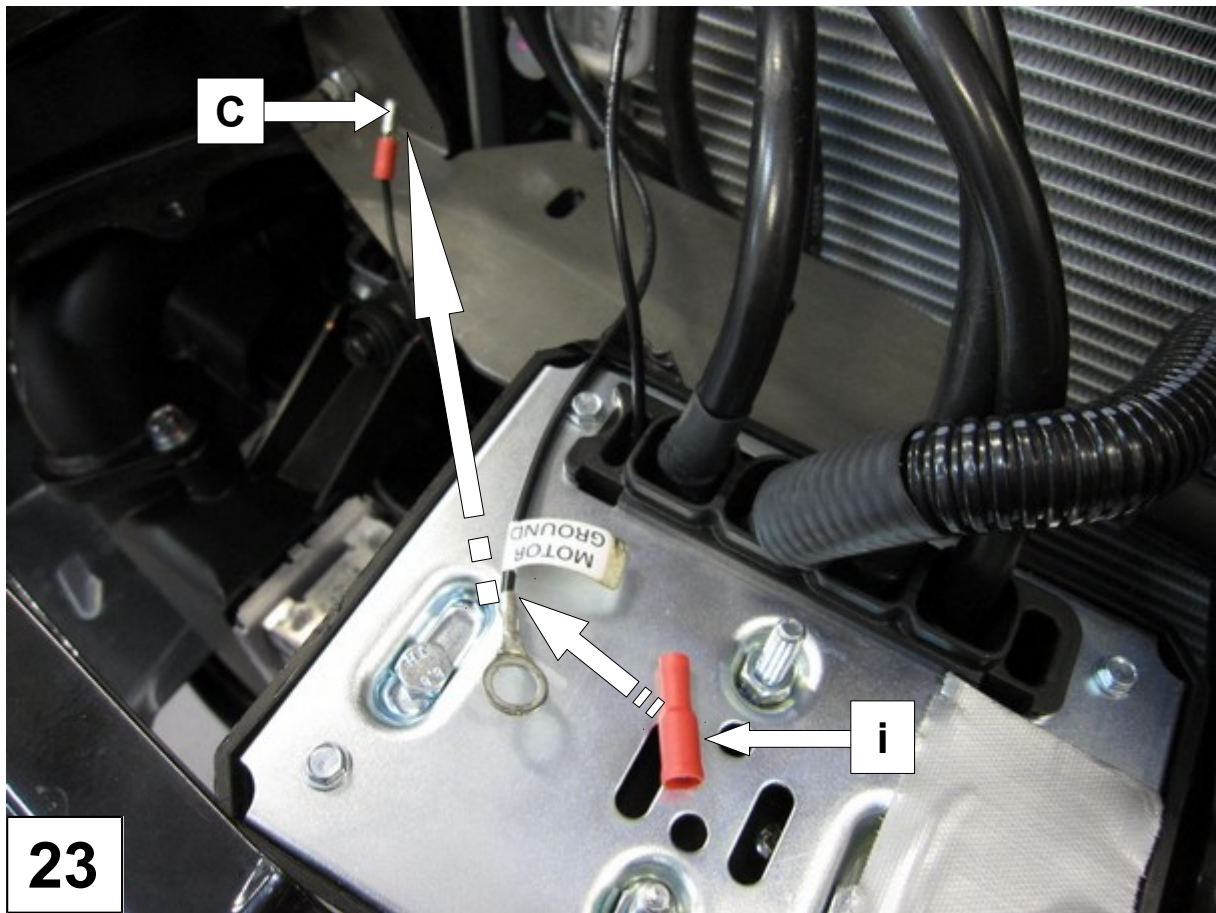

23

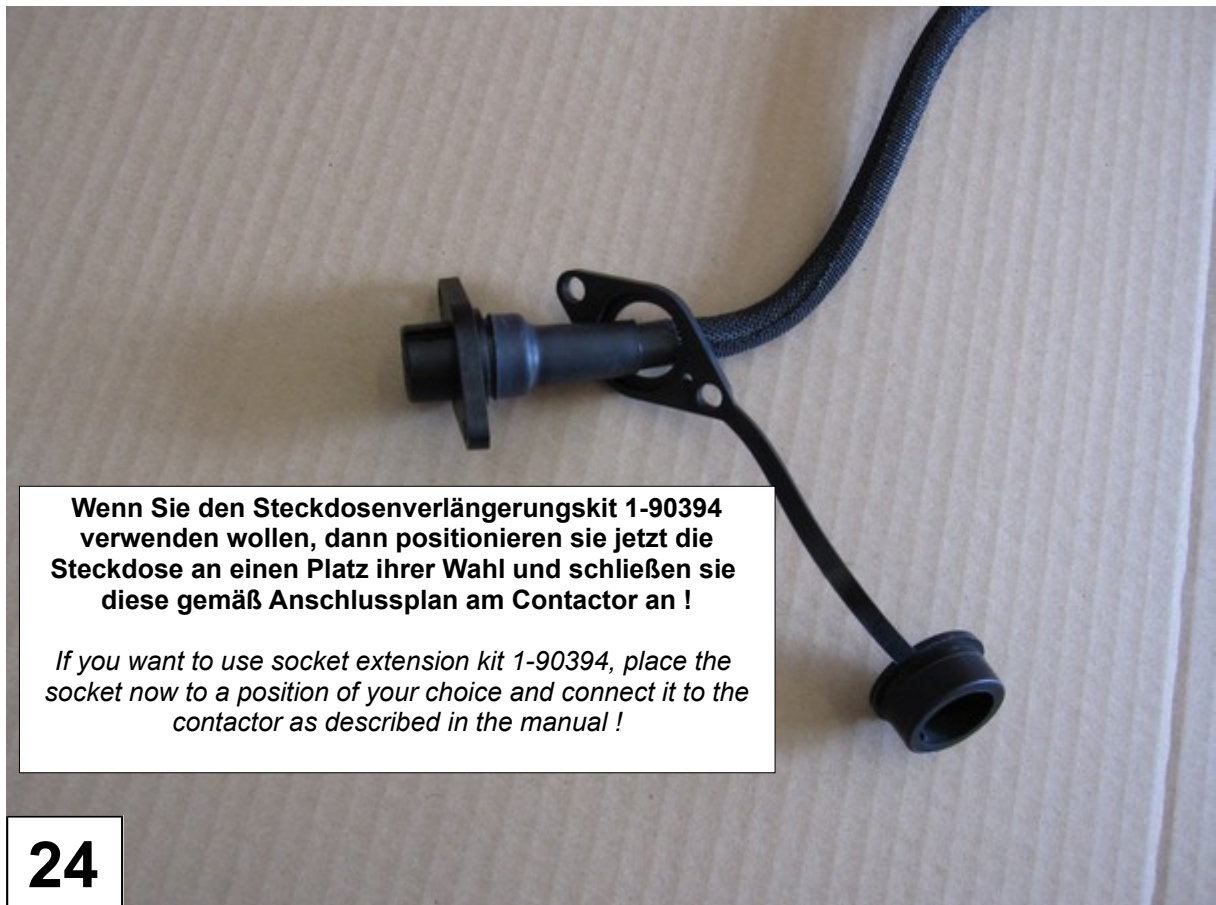

**Wenn Sie den Steckdosenverlängerungskit 1-90394 verwenden wollen, dann positionieren sie jetzt die Steckdose an einen Platz ihrer Wahl und schließen sie diese gemäß Anschlussplan am Contactor an !**

*If you want to use socket extension kit 1-90394, place the socket now to a position of your choice and connect it to the contactor as described in the manual !*

24

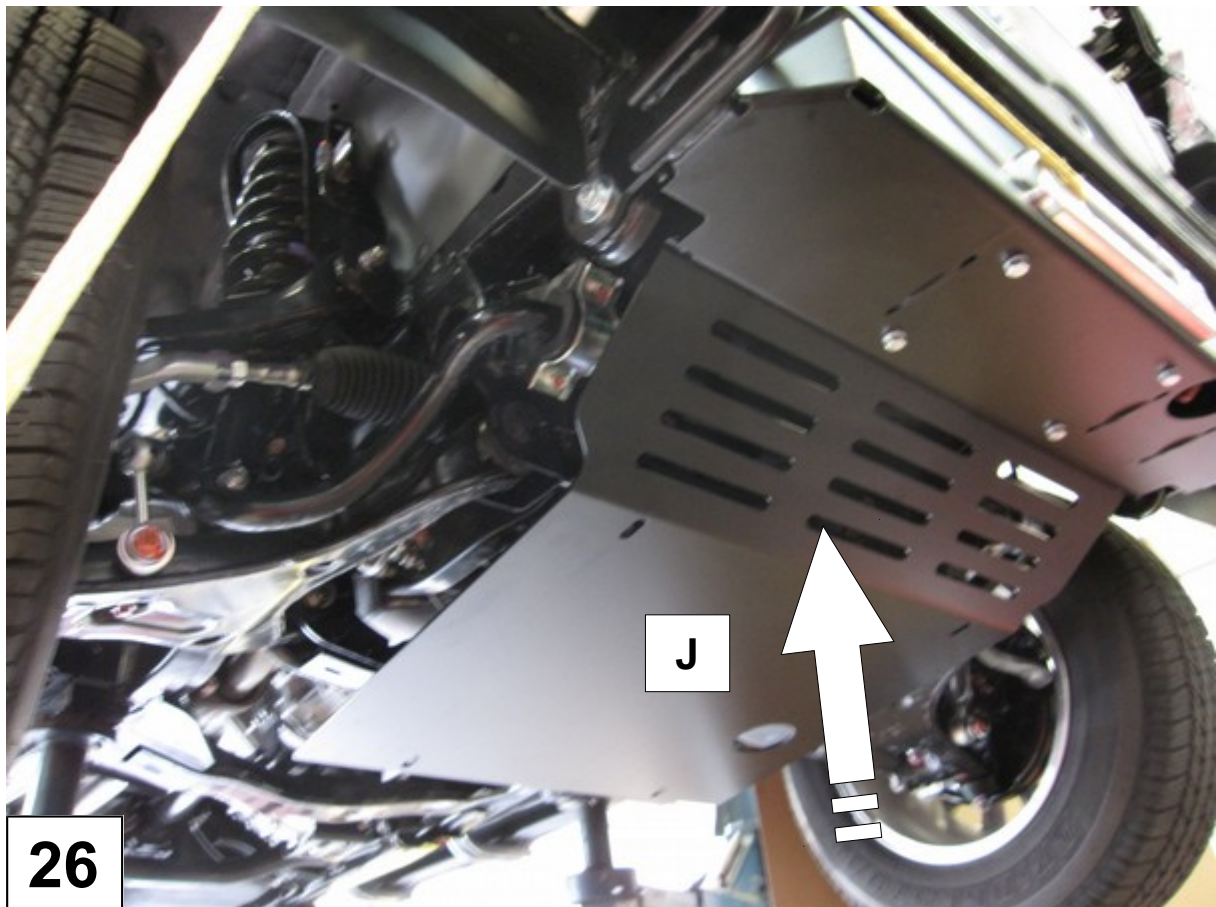
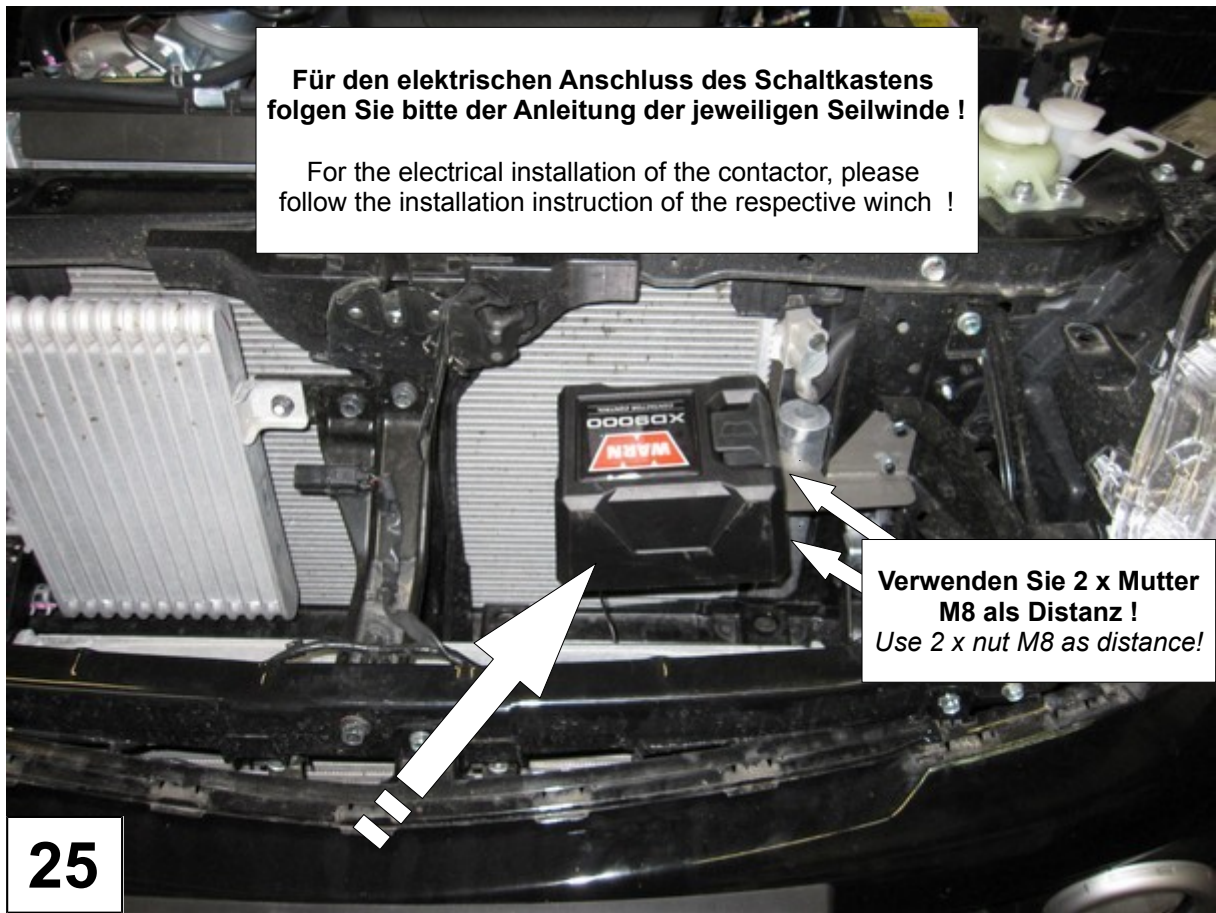

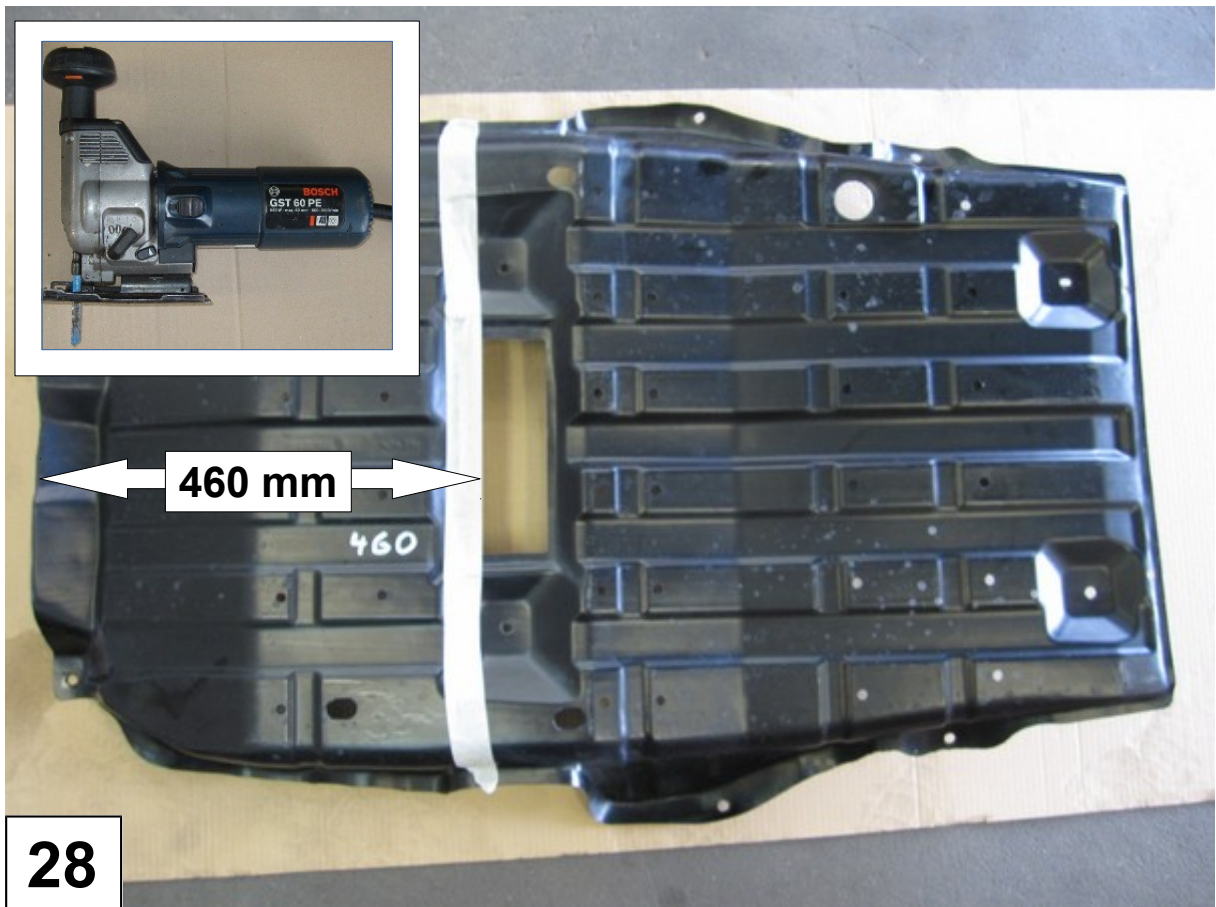
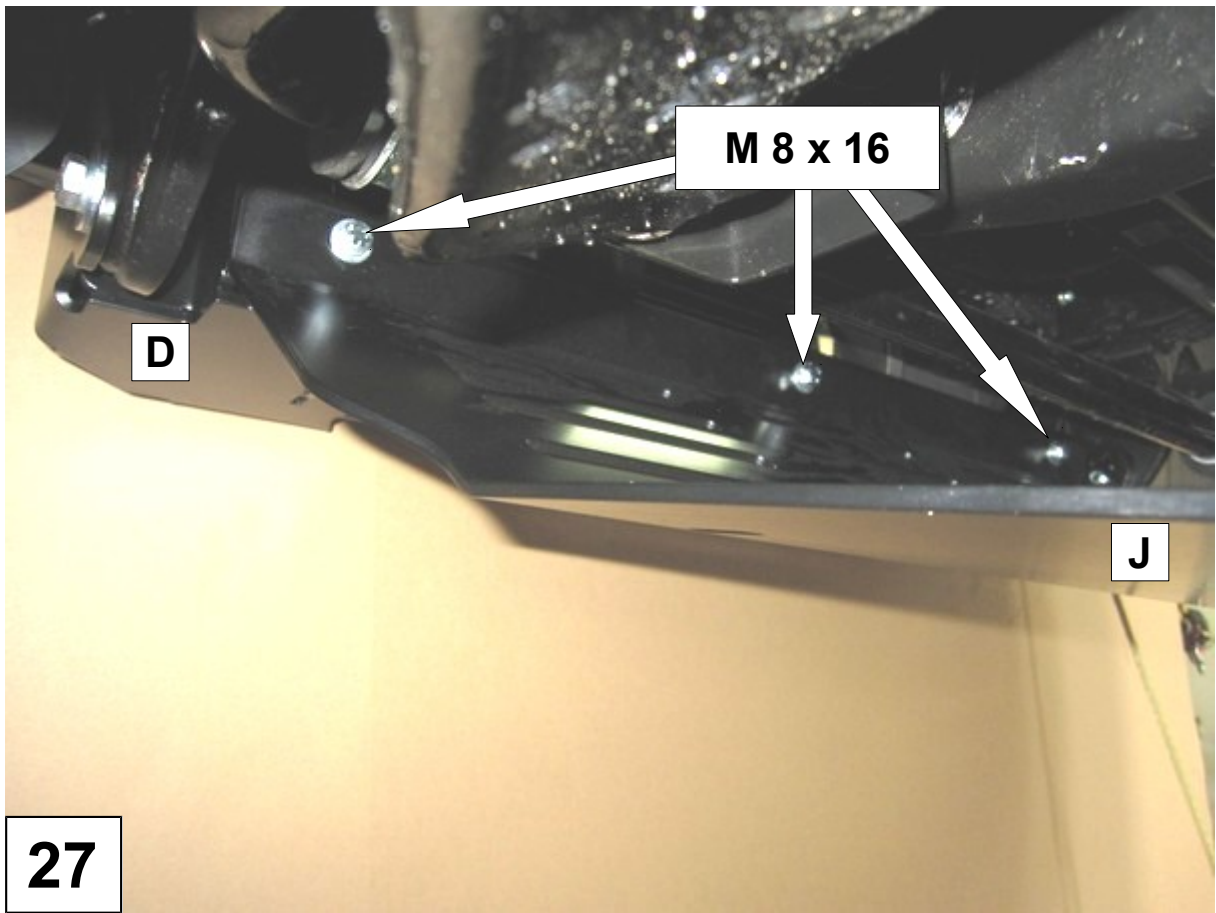



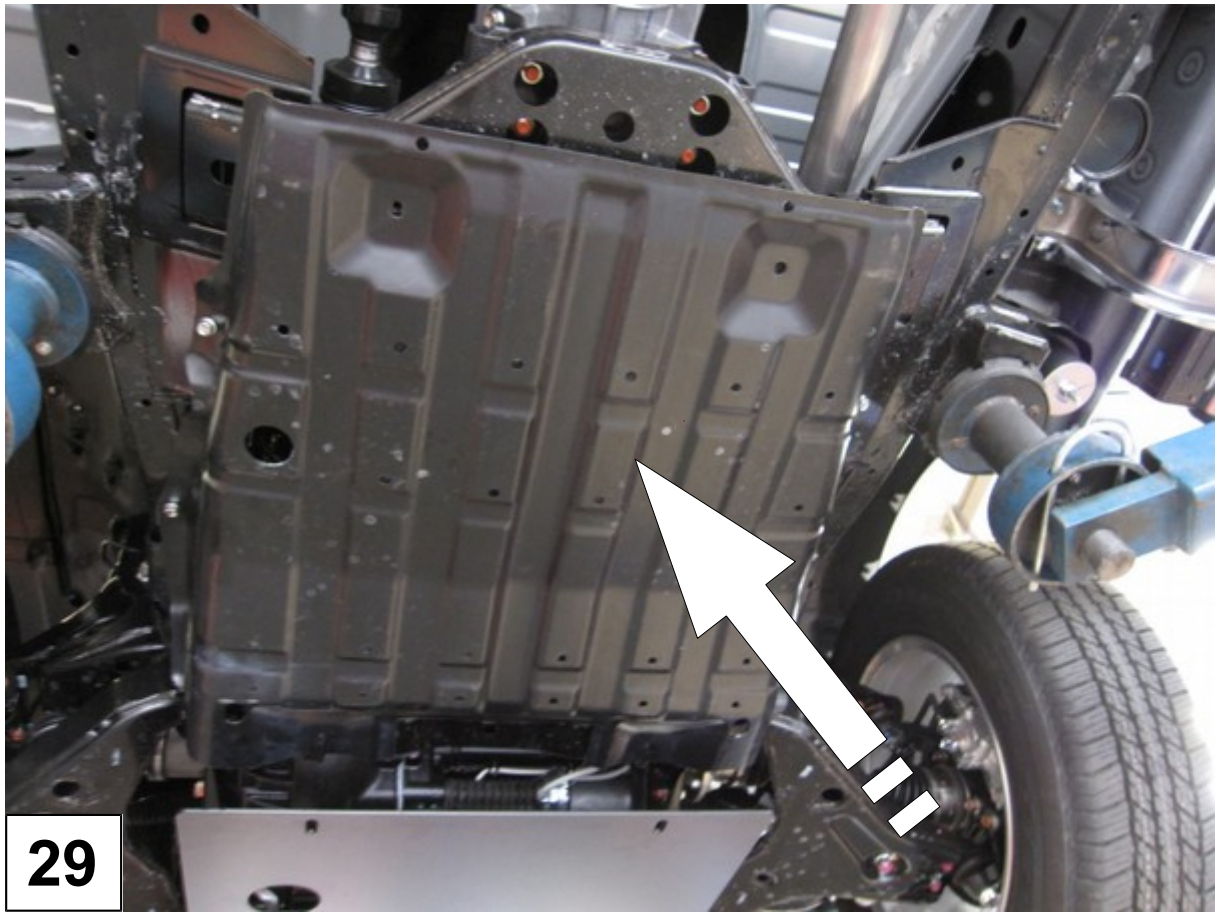

29

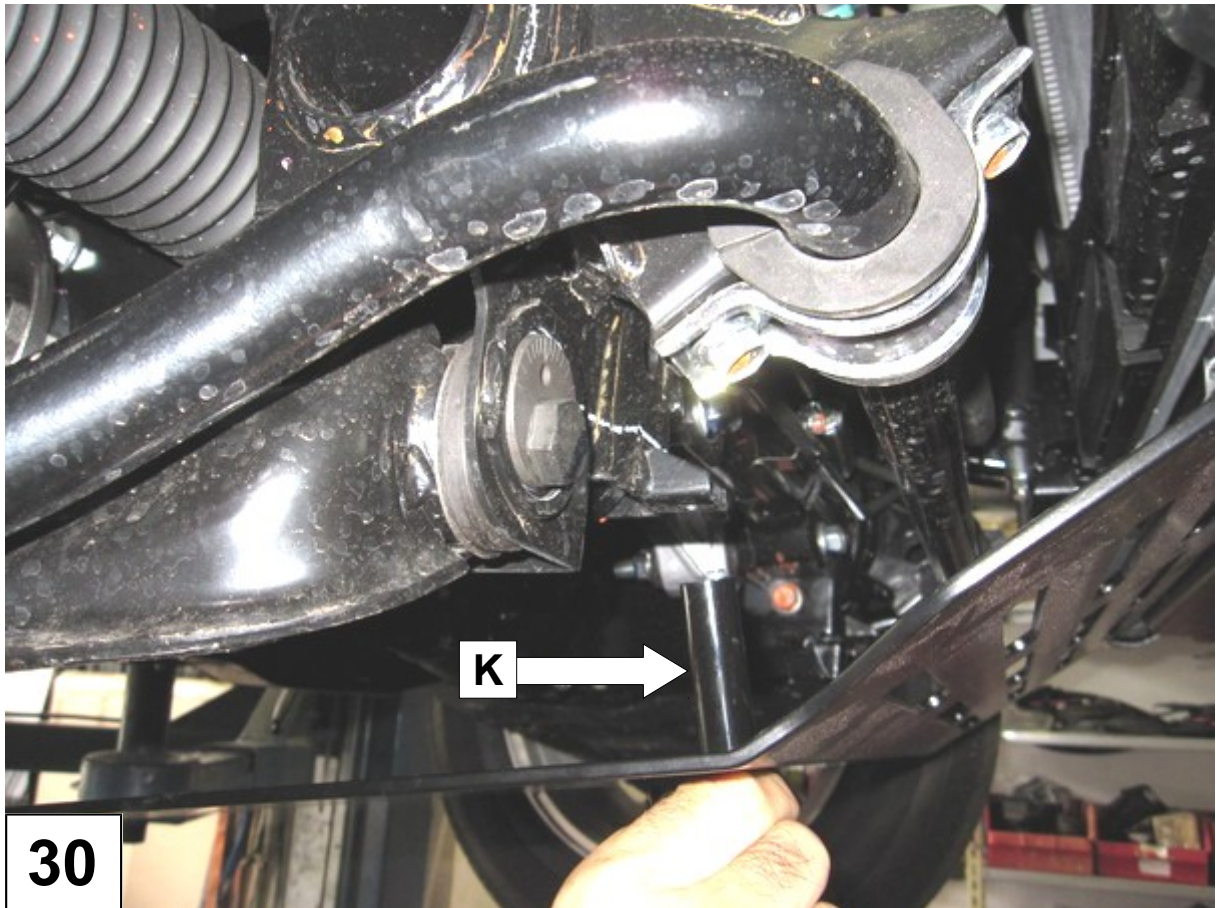

30

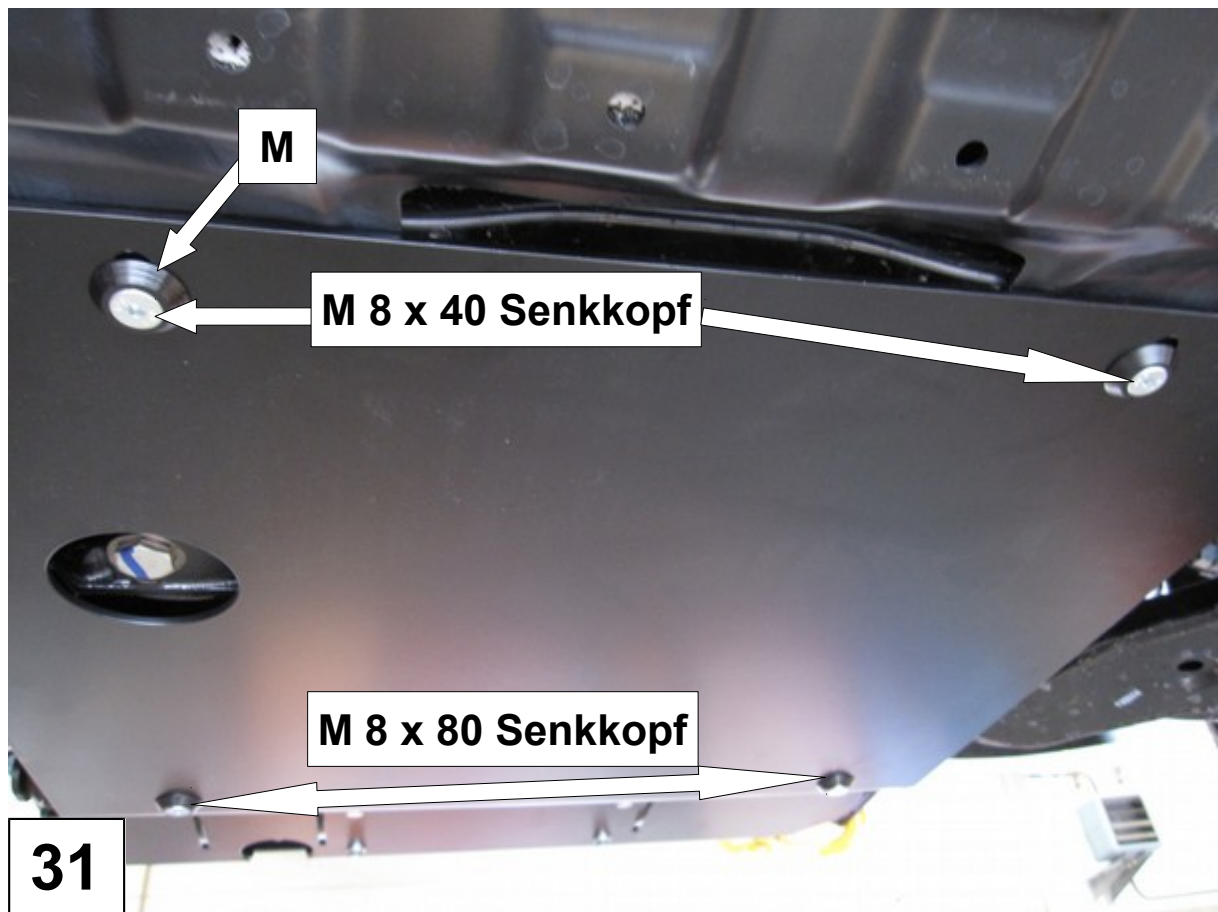

**Achtung : Ziehen Sie jetzt alle Schrauben fest !**  
*Attention: Tighten all screws now !*



